

**Dia**

---

Copyright © 2004, 2009 Kevin Breit, Henry House, Judith Samson, Alan Horkan, Mark Dexter

Permission is granted to copy, distribute and/or modify this document under the terms of the *GNU Free Documentation License*, Version 1.1 or any later version published by the Free Software Foundation with no Invariant Sections, no Front-Cover Texts, and no Back-Cover Texts. You may obtain a copy of the *GNU Free Documentation License* from the Free Software Foundation by visiting [their Web site](#) or by writing to: Free Software Foundation, Inc., 59 Temple Place - Suite 330, Boston, MA 02111-1307, USA.

Many of the names used by companies to distinguish their products and services are claimed as trademarks. Where those names appear in any GNOME documentation, and those trademarks are made aware to the members of the GNOME Documentation Project, the names have been printed in caps or initial caps.

---

<b>COLLABORATORS</b>
----------------------

	<i>TITLE :</i> Dia	
<i>ACTION</i>	<i>NAME</i>	<i>DATE</i>
WRITTEN BY	Kevin Breit, Henry House, Judith Samson, Alan Horkan, Thomas Harding, Mark Dexter, and Hans Breuer	May 23, 2017
<i>SIGNATURE</i>		

<b>REVISION HISTORY</b>
-------------------------

NUMBER	DATE	DESCRIPTION	NAME
0.97+git	2011-04-25	Work in progress for dia-0-98	hb
0.97.2	2011-04-25	Actually describing notable new features/behaviour of dia-0-97.x	hb
0.97.0	2009-02-20	Bumping dates and revisions to show progress for 0.97 release	sdteffen
0.5-2	2008-05-27	dropping HTML entities, making dia-1.xml independant from dia-cmdline.xml, dropping file extension from graphics	HDG

# Contents

<b>1</b>	<b>Introduction</b>	<b>1</b>
1.1	Introduction . . . . .	1
1.2	New in this version . . . . .	1
<b>2</b>	<b>Quickstart</b>	<b>2</b>
2.1	What Can You Do? . . . . .	2
2.2	Starting Dia . . . . .	3
2.3	Creating a Canvas . . . . .	4
2.4	Making a Diagram . . . . .	5
2.5	Saving and Printing Your Diagram . . . . .	6
2.6	Running Dia From the Command Line . . . . .	6
2.7	Who Does Dia Appeal To? . . . . .	6
<b>3</b>	<b>The Canvas</b>	<b>7</b>
3.1	Canvas Introduction . . . . .	7
3.2	Grid Lines . . . . .	7
3.3	Rulers . . . . .	8
3.4	Background Color . . . . .	8
3.5	Zooming . . . . .	9
3.6	Other View Menu Options . . . . .	11
3.7	Undo and Redo . . . . .	12
<b>4</b>	<b>Objects and the Toolbox</b>	<b>13</b>
4.1	Dia Toolbox Overview . . . . .	13
4.1.1	Modify Control . . . . .	14
4.1.2	Textedit Control . . . . .	14
4.1.3	Magnify Control . . . . .	15
4.1.4	Scroll Control . . . . .	15
4.1.5	Basic Objects . . . . .	15
4.1.6	Special Objects . . . . .	16
4.1.7	Default Color, Line Width, and Line Style . . . . .	17

---

---

4.2	Using Objects . . . . .	18
4.2.1	Adding Objects . . . . .	18
4.2.2	Moving Objects . . . . .	18
4.2.3	Resizing Objects . . . . .	19
4.2.4	Deleting Objects . . . . .	19
4.2.5	Connecting Objects With Lines . . . . .	19
4.2.6	Entering Text . . . . .	21
4.2.7	Aligning Objects . . . . .	21
4.2.7.1	How To Align Objects . . . . .	22
4.2.7.2	Left, Center, and Right Align . . . . .	22
4.2.7.3	Top, Middle, and Bottom Align . . . . .	25
4.2.7.4	Spread Out Horizontally and Vertically . . . . .	26
4.2.7.5	Align Adjacent or Stacked . . . . .	28
4.2.7.6	Align Connected . . . . .	29
4.2.8	Grouping Objects . . . . .	30
4.3	Object Properties . . . . .	31
4.3.1	Sources of Default Properties . . . . .	31
4.3.2	Changing Object Properties . . . . .	32
4.3.2.1	Changing Properties for One Object . . . . .	32
4.3.2.2	Changing Properties for a Group of Objects . . . . .	32
4.4	Colors . . . . .	32
4.4.1	Select Color Box . . . . .	33
4.5	Diagram Tree . . . . .	34
4.5.1	Opening the Diagram Tree . . . . .	34
4.5.2	Working With the Diagram Tree . . . . .	34
<b>5</b>	<b>Basic Objects</b>	<b>36</b>
5.1	Basic Objects Introduction . . . . .	36
5.1.1	Text . . . . .	36
5.1.2	Box . . . . .	37
5.1.3	Ellipse . . . . .	37
5.1.4	Polygon . . . . .	37
5.1.5	Bezierngon . . . . .	37
5.1.6	Line . . . . .	37
5.1.7	Arc . . . . .	37
5.1.8	Zigzagline . . . . .	38
5.1.9	Polyline . . . . .	38
5.1.10	Bezierline . . . . .	38
5.1.11	Line Properties . . . . .	39

---

5.1.11.1	Line Width . . . . .	40
5.1.11.2	Line Color . . . . .	40
5.1.11.3	Line Style . . . . .	40
5.1.11.4	Arrows . . . . .	41
5.1.12	Image . . . . .	41
5.1.13	Outline . . . . .	42
<b>6</b>	<b>Special Objects</b>	<b>43</b>
6.1	Special Objects . . . . .	43
6.1.1	Special Object Categories . . . . .	43
6.1.1.1	Assorted . . . . .	43
6.1.1.2	Chemical Engineering . . . . .	43
6.1.1.3	Chronogram . . . . .	44
6.1.1.4	Circuit . . . . .	44
6.1.1.5	Cisco - Computer . . . . .	44
6.1.1.6	Cisco - Misc . . . . .	44
6.1.1.7	Cisco - Network . . . . .	45
6.1.1.8	Cisco - Switch . . . . .	45
6.1.1.9	Cisco - Telephony . . . . .	46
6.1.1.10	Civil . . . . .	46
6.1.1.11	Cybernetics . . . . .	46
6.1.1.12	DIN Electrical . . . . .	46
6.1.1.13	ER . . . . .	46
6.1.1.14	Flowchart . . . . .	46
6.1.1.15	FS (Function Structure) . . . . .	47
6.1.1.16	GRAFCET . . . . .	47
6.1.1.17	Istar . . . . .	47
6.1.1.18	Jackson . . . . .	47
6.1.1.19	KAOS . . . . .	47
6.1.1.20	Map 3D Isometric . . . . .	47
6.1.1.21	Misc. . . . .	47
6.1.1.22	MSE . . . . .	47
6.1.1.23	Network . . . . .	48
6.1.1.24	PLC Ladder . . . . .	48
6.1.1.25	Pneumatic/Hydraulic . . . . .	48
6.1.1.26	SADT . . . . .	48
6.1.1.27	SDL . . . . .	48
6.1.1.28	Sybase . . . . .	48
6.1.1.29	UML . . . . .	48
6.1.2	Organizing Sheets and Objects . . . . .	49

---

---

<b>7</b>	<b>Selecting Objects</b>	<b>51</b>
7.1	Selection Introduction . . . . .	51
7.2	How To Select Objects . . . . .	51
7.2.1	Selecting a Single Object . . . . .	51
7.2.2	Deselecting Objects . . . . .	51
7.2.3	Selecting Multiple Objects . . . . .	52
7.2.3.1	Shift+Click Selection . . . . .	52
7.2.3.2	Select By Area . . . . .	52
7.2.3.3	Select All . . . . .	53
7.2.3.4	Select None . . . . .	53
7.2.3.5	Select Invert . . . . .	53
7.2.3.6	Select Transitive . . . . .	54
7.2.3.7	Select Connected . . . . .	54
7.2.3.8	Select Same Type . . . . .	54
7.3	Working With Selected Objects . . . . .	54
7.3.1	Operations on All Selected Objects . . . . .	54
7.3.1.1	Move Selected Objects . . . . .	54
7.3.1.2	Copy, Cut, Paste, Duplicate, Delete . . . . .	55
7.3.1.3	Working With Individual Objects . . . . .	55
7.3.1.4	Creating an Object Group . . . . .	55
<b>8</b>	<b>Loading and Saving Diagrams</b>	<b>56</b>
8.1	Loading and Saving Introduction . . . . .	56
8.2	File Types . . . . .	56
8.2.1	Dia Native Diagram Files . . . . .	56
8.2.2	Import/Export Formats . . . . .	56
8.2.3	Exporting Only Formats . . . . .	57
<b>9</b>	<b>Customization</b>	<b>58</b>
9.1	Preferences Dialog . . . . .	58
9.1.1	User Interface . . . . .	59
9.1.2	Diagram Defaults . . . . .	60
9.1.3	View Defaults . . . . .	61
9.1.4	File export favorites . . . . .	62
9.1.5	Grid Lines . . . . .	63

---

---

<b>10 Managing Layers</b>	<b>65</b>
10.1 Introduction to Layers . . . . .	65
10.2 Managing Layers Basics . . . . .	65
10.2.1 Create a New Layer . . . . .	66
10.2.2 Selecting Layers . . . . .	66
10.2.3 Ordering Layers . . . . .	66
10.2.4 Deleting Layers . . . . .	66
10.2.5 Renaming Layers . . . . .	66
10.3 Viewing Layers . . . . .	67
<b>11 Custom Shape Module</b>	<b>68</b>
11.1 Custom-shape Module introduction . . . . .	68
11.2 Shapes . . . . .	68
11.3 The Shape Description . . . . .	70
11.3.1 Style attribute . . . . .	70
11.3.2 Recognised drawing elements . . . . .	70
11.4 Shapes in Shapes aka. Subshapes . . . . .	72
11.5 Extended Attributes . . . . .	72
11.6 The Sheet description . . . . .	72
11.7 How Dia helps to create and manage sheets and shapes. . . . .	73
11.8 Design Notes . . . . .	73
<b>12 Dia command line</b>	<b>74</b>
12.1 Introduction . . . . .	74
12.2 Command line manual . . . . .	74
12.2.1 dia . . . . .	74
<b>13 Authors</b>	<b>77</b>
<b>14 License</b>	<b>78</b>
14.1 License . . . . .	78

---



# List of Figures

1.1	Sample Flowchart Diagram . . . . .	1
2.1	Sample Network Diagram . . . . .	3
2.2	Dia tabbed diagramming . . . . .	4
2.3	Dia Startup . . . . .	5
3.1	Diagram / Properties / Grid . . . . .	7
3.2	Snap-To-Grid Toggle Button . . . . .	8
3.3	Ruler With Arrows Circled in Red . . . . .	8
3.4	Changing Background Color . . . . .	9
3.5	Toolbox Magnify . . . . .	9
3.6	Canvas Zoom . . . . .	9
3.7	View Menu Zoom Options . . . . .	10
3.8	View Menu . . . . .	11
4.1	Dia Toolbox . . . . .	13
4.2	Modify Control . . . . .	14
4.3	Textedit Control . . . . .	14
4.4	Magnify Control . . . . .	15
4.5	Scroll Control . . . . .	15
4.6	Special Objects . . . . .	16
4.7	Default Color, Line Width, and Line Style . . . . .	17
4.8	Restore Default Colors Button . . . . .	17
4.9	Reverse Colors Button . . . . .	17
4.10	Default Line Width . . . . .	17
4.11	Arrow and Line Style . . . . .	18
4.12	Object Handles . . . . .	18
4.13	Line Handles . . . . .	19
4.14	Line Connected . . . . .	20
4.15	Fixed Connection Point . . . . .	20
4.16	Middle Connection Point . . . . .	20

---

---

4.17	Edit Menu Text Commands . . . . .	21
4.18	Objects / Align Options . . . . .	22
4.19	Before Left, Center, Right Align . . . . .	23
4.20	Align Left . . . . .	23
4.21	Align Center . . . . .	24
4.22	Align Right . . . . .	24
4.23	Before Top, Middle, Bottom Align . . . . .	25
4.24	Align Top . . . . .	25
4.25	Align Middle . . . . .	26
4.26	Align Bottom . . . . .	26
4.27	Before Spread Out Horizontally . . . . .	26
4.28	After Spread Out Horizontally . . . . .	27
4.29	Before Spread Out Vertically . . . . .	27
4.30	After Spread Out Vertically . . . . .	28
4.31	Align / Adjacent . . . . .	28
4.32	Align / Stacked . . . . .	29
4.33	Before Align Connected . . . . .	29
4.34	After Align Connected . . . . .	30
4.35	Before and After Group Create . . . . .	30
4.36	Default Text Properties . . . . .	31
4.37	Default Box Properties . . . . .	31
4.38	Color Listbox . . . . .	33
4.39	Select Color Box . . . . .	33
4.40	Diagram Tree . . . . .	35
5.1	Basic Objects . . . . .	36
5.2	Zigzagline Right-Click Menu . . . . .	38
5.3	Polyline Right-Click Menu . . . . .	38
5.4	Bezierline Right-Click Menu . . . . .	39
5.5	Standard Line Properties . . . . .	40
5.6	Line Styles . . . . .	40
5.7	Line Caps . . . . .	41
5.8	Line Arrows . . . . .	41
5.9	Image . . . . .	42
6.1	Assorted . . . . .	43
6.2	Cisco - Computer . . . . .	44
6.3	Cisco - Misc . . . . .	44
6.4	Cisco - Network . . . . .	45

---

---

6.5	Cisco - Switch . . . . .	45
6.6	Cisco - Telephony . . . . .	46
6.7	Flowchart . . . . .	46
6.8	Misc . . . . .	47
6.9	Network . . . . .	48
6.10	UML . . . . .	48
6.11	UML Class Properties . . . . .	49
6.12	Sheets and Objects . . . . .	50
7.1	Selected Object . . . . .	51
7.2	Select By Area Example . . . . .	52
7.3	Select Menu . . . . .	53
9.1	User Interface . . . . .	59
9.2	Diagram Defaults . . . . .	60
9.3	View Defaults . . . . .	61
9.4	File export favorites . . . . .	62
9.5	Grid Lines . . . . .	63

---

# Chapter 1

## Introduction

### 1.1 Introduction

Dia is an application for creating technical diagrams. Its interface and features are loosely patterned after the Windows program Visio. Features of Dia include multiple-page printing, export to many formats (EPS, SVG, CGM and PNG), and the ability to use custom shapes created by the user as simple XML descriptions. Dia is useful for drawing UML diagrams, network maps, and flowcharts.

This document describes version 0.97 of Dia.

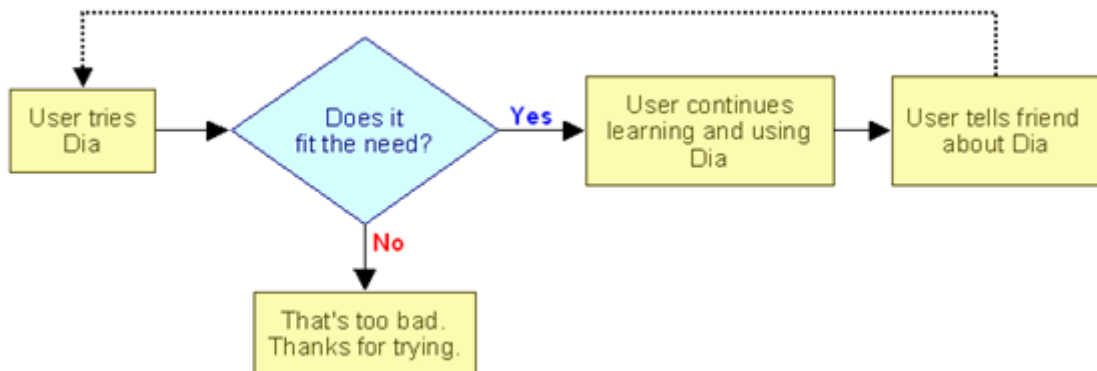

Figure 1.1: Sample Flowchart Diagram

### 1.2 New in this version

- Transparency with [colors](#)
- Transformations, see [Grouping Objects](#) - ToDo update for 0.97: property change working on selection, 0.98: transformations of groups
- Object meta info editor, see [Changing Properties](#)
- Embedded images ...

## Chapter 2

# Quickstart

The Dia Quickstart is designed to help you get started creating diagrams with Dia without having to read a manual.

### 2.1 What Can You Do?

Dia is a diagramming application that can be used to make a large variety of diagrams. Dia is easy to learn and flexible enough to allow power users to create highly customized diagrams. Below are two simple examples of diagrams that can quickly be created using Dia.

---

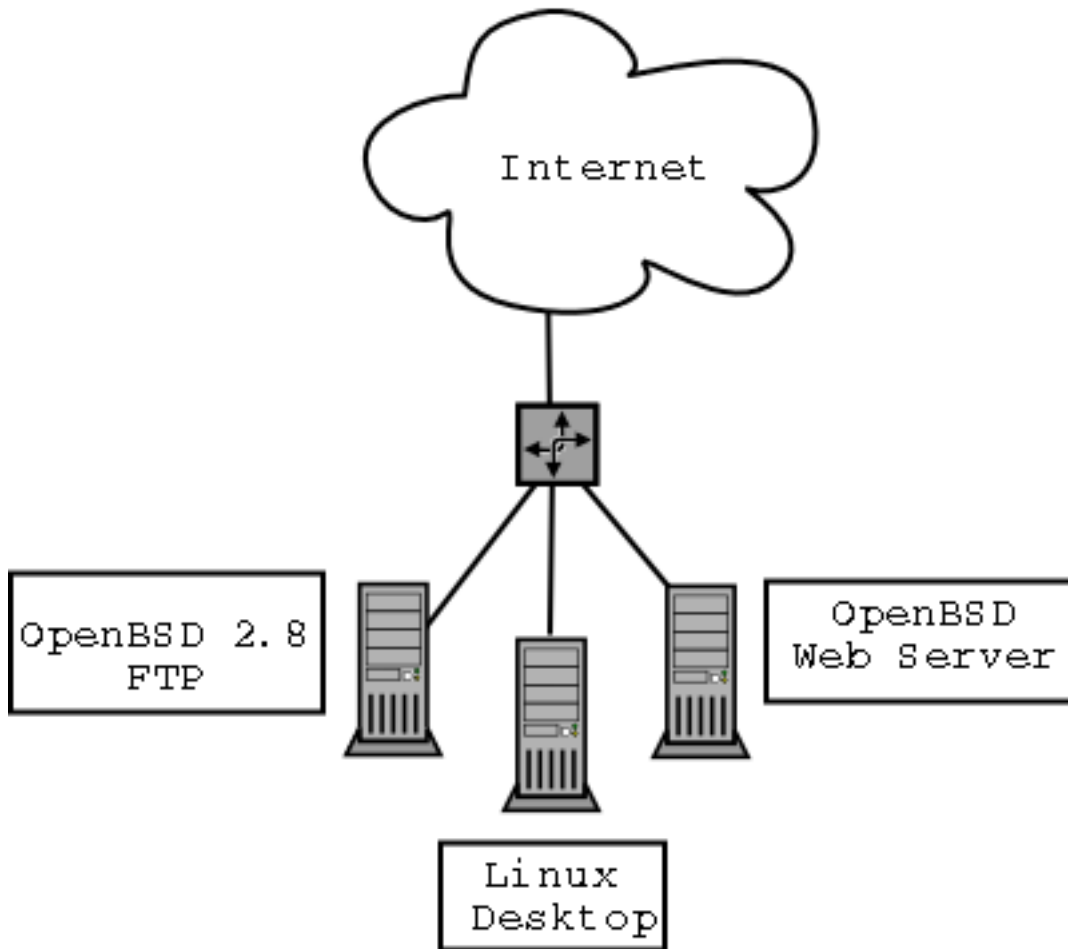
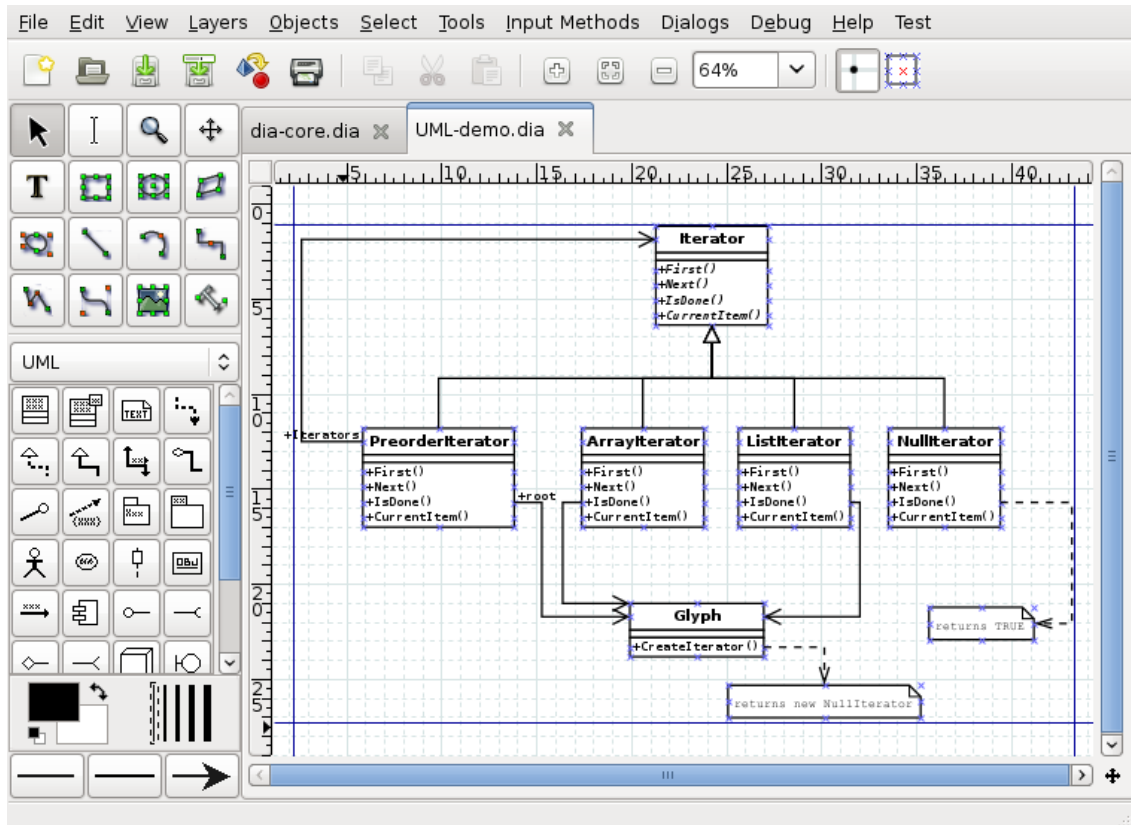

Figure 2.1: Sample Network Diagram

## 2.2 Starting Dia

You can start Dia by going into the Applications section on the Main Menu and clicking on the Dia icon. Or, you can type **dia** in a console window or xterm.



Create the tabbed interface by **dia --integrated**.

Figure 2.2: Dia tabbed diagramming

## 2.3 Creating a Canvas

All diagrams are drawn in their own *canvas*. When you first start Dia, a blank canvas is created automatically. At any time, you can create a new canvas by selecting `File → New Diagram`. The canvas may be customized in various ways, such as changing the background color or grid lines. See [The Canvas](#) for more information on customizing the canvas.

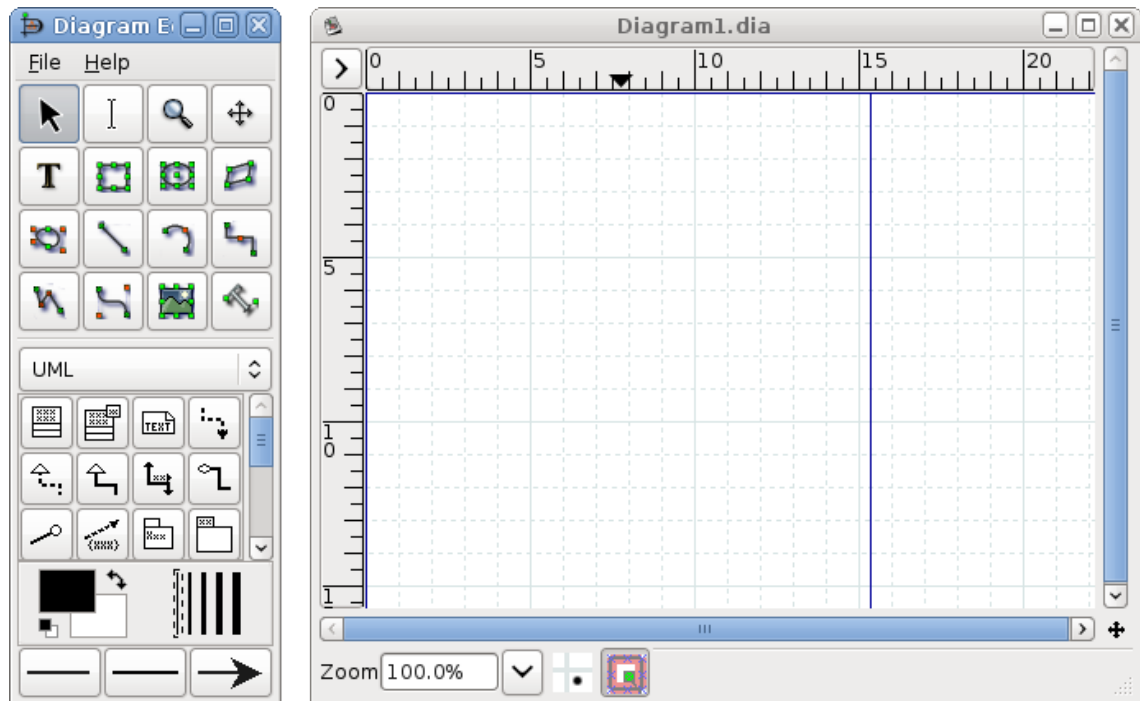

Dia startup showing blank canvas above and Toolbox.

Figure 2.3: Dia Startup

## 2.4 Making a Diagram

A diagram is made up of objects. Objects are shapes or lines that can be different colors and sizes. Objects can be simple line drawings, text, or full-color pictures. Some objects allow text to be entered inside the shape.

Using Dia to create a diagram is easy. The Toolbox contains a palette of predefined objects, including simple shapes, lines, and specialized objects. To add an object to the canvas, simply click on the desired object's icon on the Toolbox and then click on the desired point on the canvas. The object will appear on the canvas where you clicked. See [Adding Objects](#) for more information.

An object can be moved by clicking on the object and dragging the mouse. The object can be resized by clicking and dragging one of the object's green or red "handles". See [Moving Objects](#) and [Resizing Objects](#) for more information on moving and resizing objects.

Objects can be connected using lines. Just drag each end of a line to any connection point (small blue "x") on an object. Once objects are connected, they can be moved and the line stretches to keep them connected. See [Connecting Objects With Lines](#) for more information on how to connect objects.

In the Toolbox, you can double-click on any object's icon to view and edit the object's default properties. This allows you to customize various default properties of each object. For objects that include text, you can customize the text alignment and font properties. For standard shapes, you can customize the transparency, the corner shape, and the aspect ratio. See [Sources of Default Properties](#) for more information about changing default properties.

Dia includes a set of standard shape and line objects. See [Objects](#) for more information on working with the standard objects. Dia includes a large number of predefined objects for various uses. These include flowcharts, UML diagrams, network diagrams, and many others. See [Special Object Categories](#) for more information on the various objects available.

Many common tasks in Dia require selecting one or more objects. Dia includes a number of ways to select objects quickly. See [Selecting Objects](#) for more information.

Dia can be customized in a number of ways. See [Customization](#) for more information on customization.



Layers create multiple-images so they are one image. By doing this, a user can edit one layer without worrying about affecting any of the other layers. See [Managing Layers](#) for more information on working with layers.

Dia is designed to make adding new user-defined shapes very easy. See [Custom Shape Module](#) for more information on creating your own custom shapes.

## 2.5 Saving and Printing Your Diagram

Dia provides the normal save and print options, located on the File menu. Selecting the File → Page Setup allows you to set the paper size, orientation, and print margins. This also allows you to choose whether to print the diagram to scale (entered in percent) or to fit the diagram to a specific size (in centimeters).

Dia supports exporting to numerous formats for excellent web publishing. Some of them include:

- Computer Graphics Metafile (.cgm)
- Encapsulated Postscript (.eps)
- Portable Document Format (.pdf)
- Portable Network Graphics (.png)
- Scalable Vector Graphics (.svg)

See [Loading and Saving Diagrams](#) for more information.

---

### Note

On some Windows systems, Dia diagrams do not print correctly. This problem can be worked around by exporting the diagram -- for example to Portable Networks Graphics (.png) format -- and then printing the exported .png file.

---

## 2.6 Running Dia From the Command Line

Dia can be run from the command line. This allows certain Dia capabilities to be used in batch script files. See [Dia Command Line](#) for more information on creating your own custom shapes.

## 2.7 Who Does Dia Appeal To?

Dia can be used by many people in a variety of industries.

- A systems engineer can create [SADT](#) diagrams for system analysis and design.
  - A requirements engineer can compose e.g. [RE-KAOS](#), RE-Jackson or RE-I\* diagrams.
  - A software developer can create [UML](#) diagrams of various types and extend them with the flexibility of a general purpose diagram tool.
  - A database designer can represent data relations with [ER diagrams](#).
  - A control engineer may draw [Cybernetics](#) diagrams.
  - A computer programmer can create a flow chart to show the execution path of a program.
  - A network administrator can create a diagram to model the company's company network.
  - An electrical engineer may use Dia to create a diagram to show how a circuit works.
  - An mechanical engineer may design some Hydraulic or Pneumatic diagrams.
-

## Chapter 3

# The Canvas

### 3.1 Canvas Introduction

The Dia canvas is the window that contains the diagram. All of the user's objects are placed and arranged on the canvas.

### 3.2 Grid Lines

Grid lines are similar to the lines on graph paper. They allow the user to easily align objects on the canvas. The grid lines can be temporarily hidden for the current document by selecting **View** → **Show Grid**.

Grid line properties can be modified by selecting **Diagram** → **Properties**, which brings up the dialog shown in the figure below.

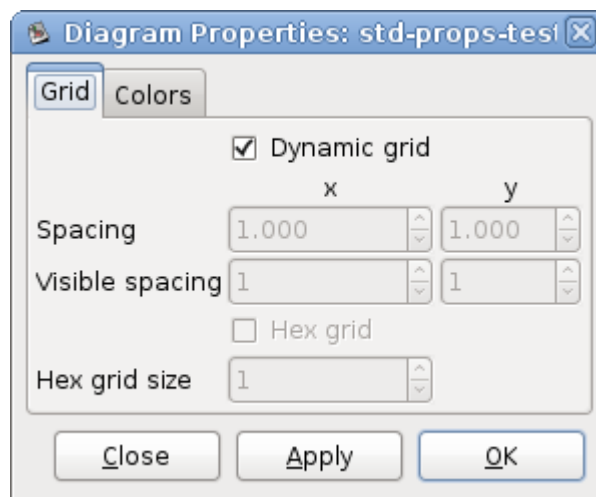

Figure 3.1: Diagram / Properties / Grid

If the **Dynamic grid** box is checked, the grid adjusts automatically to keep the same visible spacing as the diagram view is zoomed in or out. Also, when this box is checked, the other options on the dialog are disabled.

If the **Dynamic grid** box is unchecked, then the grid spacing remains the same in absolute terms. So when the view is zoomed out, the grid appears smaller, and when the view is zoomed in, the grid appears larger.

The **Spacing** for the x and y coordinates is in centimeters and can be typed or entered using the increment / decrement buttons. The **visible spacing** determines which grid lines are visible. A value of 1 indicates that all grid lines are visible, 2 indicates that every second line is visible, and so on. Note that the snap-to-grid works the same whether or not grid lines are visible.

The Hex grid checkbox allows you to create a grid of hexagons instead of squares. The Hex grid size is also in centimeters.

The snap-to-grid feature may be toggled on and off using the snap-to-grid button located below the canvas. When this is enabled, objects are forced to align on a grid line.

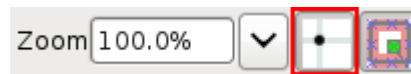

Figure 3.2: Snap-To-Grid Toggle Button

### 3.3 Rulers

Rulers appear on the top and the left of the Dia canvas. They show, in centimeters, how large your canvas is. A centimeter on the screen will not necessarily equal an actual centimeter. This will depend on your monitor's dots-per-inch (DPI) setting and your current zoom percentage. For example, if your monitor is set to 96 DPI and your zoom percentage is about 185%, then the display ruler is at actual scale. Regardless of these settings, you can always see how big your objects and diagram are using the on-screen ruler.

---

#### Note

When you print a diagram and select the option Scaling / Scale of 100.0%, the diagram will be printed to scale regardless of the printer's DPI setting or the view zoom factor.

---

Each ruler has an arrow that moves along the ruler to show the exact coordinate of the mouse pointer. For example, if the user moves the mouse up, the vertical ruler's arrow will move up, indicating the change. These arrows are useful when an object needs to line up exactly at a certain measurement point.

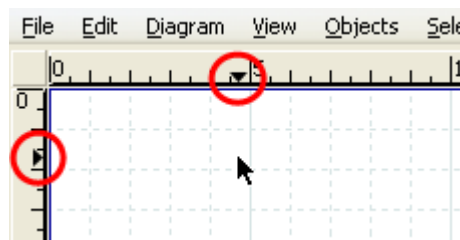

Figure 3.3: Ruler With Arrows Circled in Red

Rulers can be temporarily hidden for the current document by choosing the menu item View → Show Rulers . Unlike grid lines, rulers cannot be turned off by default for new documents.

### 3.4 Background Color

The background color option allows you to change the color of the canvas. By default, the color is white. However, the color can be changed by selecting Diagram → Properties and then selecting the "Colors" tab. The first color option is Background. You can change the color by selecting the drop-down list box and then using the standard color selection options. See [Objects / Colors](#) for more information about selecting colors.

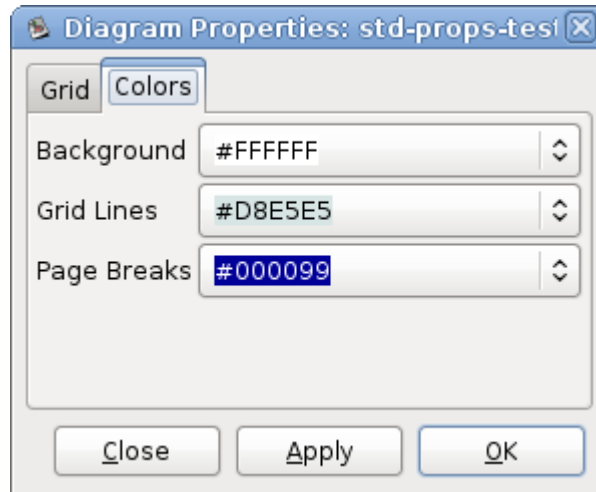

Figure 3.4: Changing Background Color

---

**Note**

The gridlines will change their color automatically to stay visible if the background color is changed to black.

---

## 3.5 Zooming

Zooming allows the user to zoom in (make things bigger) or zoom out (make things smaller). Zooming in is useful when you are trying to make your drawing very precise. Zooming out is useful when you want to view a larger portion of the diagram.

The canvas can be zoomed in to 2500% and out to 5%. Zooming can be done in several ways.



Figure 3.5: Toolbox Magnify

The Toolbox contains a Magnify tool. If you select the Magnify tool and then click anywhere on the canvas, the diagram is zoomed in at that point by a factor of two (e.g., from 100% to 200%). Shift+Click reverses the process (i.e., zooms out by a factor of two).

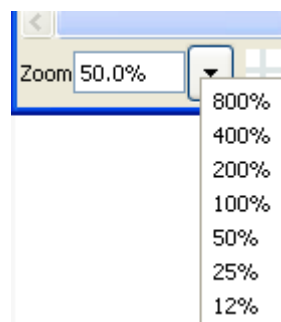

Figure 3.6: Canvas Zoom

---

Dia has a zoom control at the lower left corner of the canvas. This control allows you to enter in a zoom percentage or to select from a series of fixed zoom percentages.

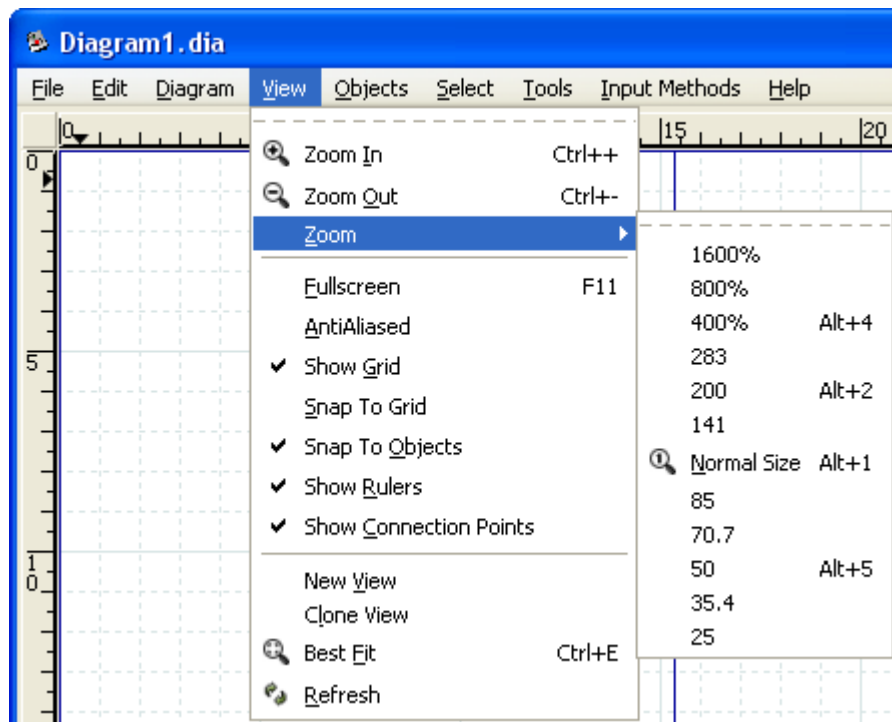

Figure 3.7: View Menu Zoom Options

The View menu has options for Zoom In (Ctrl++); Zoom Out (Ctrl+-); Zoom to a choice of fixed percentages; and Best Fit (Ctrl+E).

---

#### Tip

The Ctrl+E (Zoom to Best Fit) is very useful for fitting the entire diagram in the window. It also provides a quick way to see if there are any objects outside the current view area.

---

### 3.6 Other View Menu Options

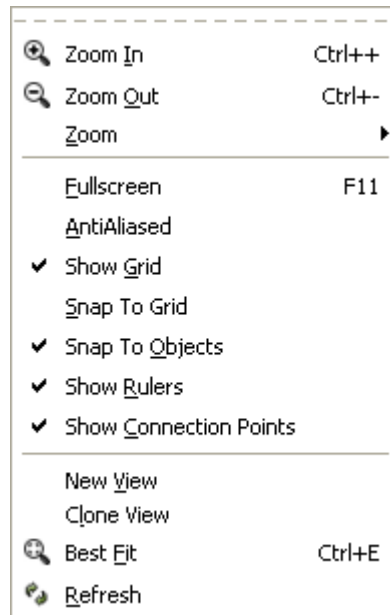

Figure 3.8: View Menu

In addition to the zoom options discussed above, the View menu provides a number of useful functions. These are discussed below.

- Fullscreen (F11) toggles between the normal window view and full-screen view.
- AntiAliased toggles the antialiased feature on and off.
- Show Grid toggles the display of the grid on and off.
- Snap To Grid toggles the snap-to-grid property on and off.
- Snap To Objects toggles the snap-to-objects property on and off. When this is on, lines can be connected to the middle connection point of an object by dragging the line end handle to any point inside the object. When this is off, the line's connection handle must be dragged to the middle connection point of the object being connected.
- Show Rulers toggles the ruler display on and off.
- Show Connection Points toggles the connection points display on and off.
- New View opens a new window that displays the same diagram. This can be useful if you want to see and work on different sections of a diagram at the same time.

---

**Tip**

If you use New View or Clone View to open a second window on a diagram, changes you make in one window display immediately in the other window. If you open the same diagram file in two different instances of the application (e.g., using File / Open), you must save changes made in one session and re-load the diagram in the second session before they will be visible to the second session. For this reason, using New View or Clone View is normally preferred.

---

- Clone View is the same as New View except that it copies the zoom and size of the first view instead of using the default values.
  - Best Fit automatically zooms to the highest zoom value that will fit the entire diagram in the window.
-

- Refresh redraws the diagram on the canvas. Normally this is not needed. Occasionally when making changes to a diagram, however, the screen will not redraw correctly. For example, a portion of a deleted line might still display. If this happens, Refresh correctly redraws the canvas.

### **3.7 Undo and Redo**

Dia supports Undo and Redo on most operations. To undo an operation, press Ctrl+Z or select Edit → Undo from the diagram menu bar. To redo an operation, press Ctrl+Shift+Z or select Edit → Redo from the diagram menu bar.

---

## Chapter 4

# Objects and the Toolbox

A diagram in Dia consists of a set of objects. Objects are shapes that are either predefined or user-defined. The Toolbox allows you to select the desired object and allows you to set default properties for objects.

### 4.1 Dia Toolbox Overview

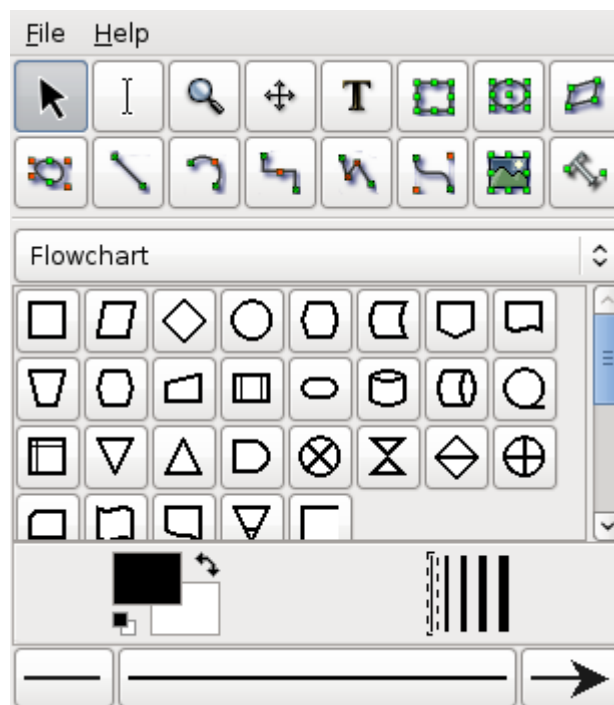

Figure 4.1: Dia Toolbox

When Dia is executed, two windows open: the canvas, which contains the diagram, and the Toolbox, which contains the object palettes and other controls. The Toolbox is divided into three regions. The top region contains 14 buttons. The first three are controls used to adjust the diagram. The next 11 are the icons for the built-in basic objects.

The middle portion of the Toolbox contains the selected Special Objects. This is used to select among the many built-in object sheets supplied with Dia, such as UML, Flowchart, Network, etc.



The bottom portion of the Toolbox contains special controls that set default properties for objects placed on the canvas. These include foreground color, background color, and line width. There are also three controls that set the default properties for line objects. These are beginning arrow style, ending arrow style, and line style.

### 4.1.1 Modify Control



Figure 4.2: Modify Control

The Modify control is the default setting when using Dia. This control allows you to select one or more objects on the canvas. After an object is added to the diagram, the Modify control is automatically selected for you. This makes it easy to add an object and then continue working without having to reselect the Modify control.

---

**Tip**

You can toggle between an object control and the Modify control using the Space key. For example, say you wish to add several Box objects to the diagram. First, click on the Box icon and click on the canvas to add the Box. At this point, the Modify control will be selected automatically. To reselect the Box control, press the Space key. Now you can click on the canvas again to add a second Box object. Continue to press Space and then click to add as many Box objects as desired.

---

---

**Tip**

You can customize Dia to disable the automatic selection of the Modify control. See [Customization / User Interface](#) for more information.

---

### 4.1.2 Textedit Control



Figure 4.3: Textedit Control

The Textedit control is new with Dia from version 0.97 - it indicates being in text edit mode. Together with an appropriate object selection it is one way to start text modification.

An object supporting in-canvas text editing can be in two different selection modes. The normal selection is the same for all objects, it allows to manipulate the objects position, grouping etc.. Some object can enter a second selection mode, which allows to edit their text from the canvas.

---

**Tip**

There are multiple ways to enter text edit mode. You can press-and-hold the left mouse button, activate text editing by Enter or F2 key or select the respective object after activating Textedit from the toolbox.

---

### 4.1.3 Magnify Control



Figure 4.4: Magnify Control

The Magnify control is one method for zooming in or out. See [The Canvas / Zooming](#) for more information about zooming. The Magnify control stays active until you press one of the other controls.

### 4.1.4 Scroll Control



Figure 4.5: Scroll Control

The Scroll control is used to move around the diagram. When this control is active, the mouse pointer changes to a hand. When the Scroll control is active, you can scroll around the diagram by clicking anywhere on the canvas and dragging the mouse. The diagram scrolls within the canvas window. The Scroll control stays active until you press one of the other controls.

### 4.1.5 Basic Objects

After the Modify, Zoom, and Scroll controls, the next 11 buttons allow you to place Dia's basic objects on the canvas. See [Basic Objects Introduction](#) for more information on Dia's basic objects.

## 4.1.6 Special Objects

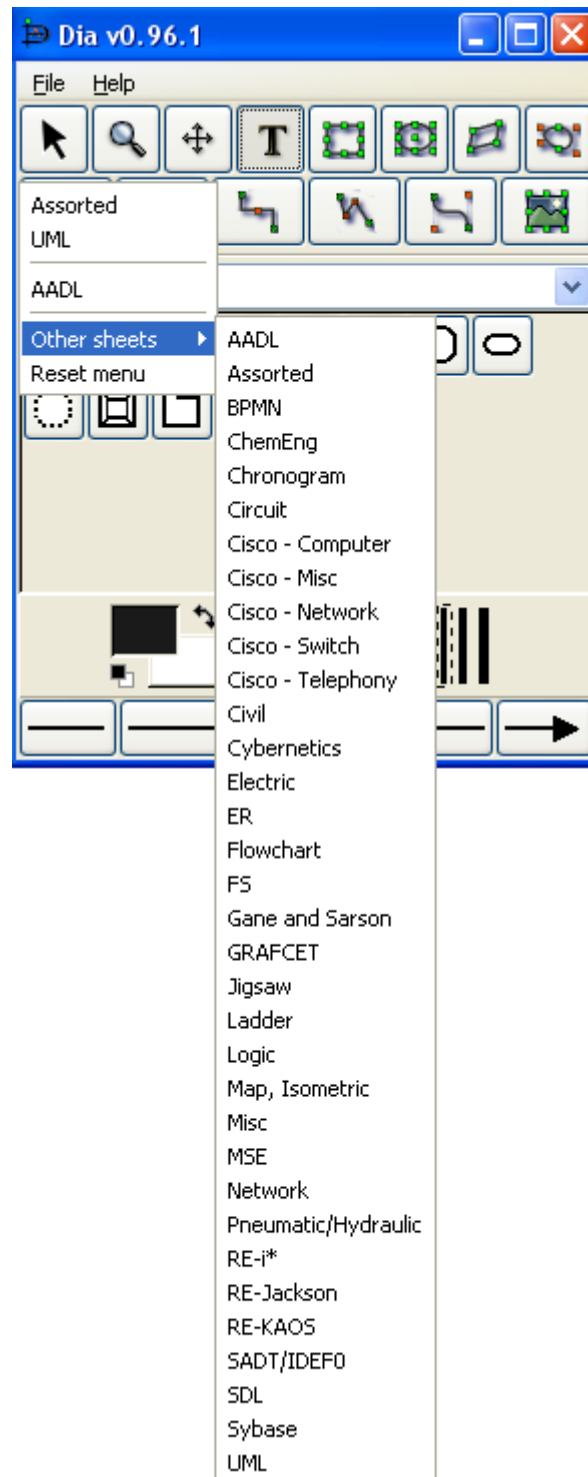

Figure 4.6: Special Objects

On the Toolbox, just below the basic object icons, is a drop-down listbox that allows you to select a sheet of special objects to be included in the diagram. As you can see from the screenshot above, Dia provides a large number of special objects. To use a special object, first select the desired sheet using this drop-down listbox. Then, just click on the desired object and click on the

canvas to insert the object. See [Special Object Categories](#) for more information on the various types of special objects available.

#### 4.1.7 Default Color, Line Width, and Line Style

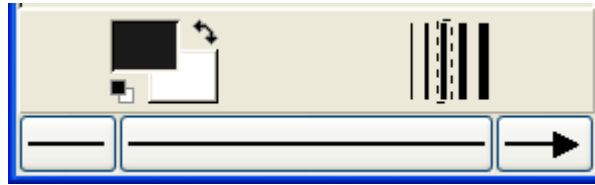

Figure 4.7: Default Color, Line Width, and Line Style

Below the special objects palette are controls for setting the default foreground and background color, line width, and line style. These controls all set default properties for new objects being added to the canvas. They do not affect the properties of existing objects already on the palette. These settings stay in effect for all future Dia sessions, until they are changed.

The two squares on the left allow you to set the default foreground and background colors for all new objects being added to the diagram. If you double-click on the upper square (i.e., the black one in the screenshot above), you can set the default foreground color for all new objects. Double-clicking on the lower square (white in the screenshot) allows you to select the default background color. See [Objects / Colors](#) for more information about selecting colors.

---

#### Tip



Figure 4.8: Restore Default Colors Button

To set the colors back to the default, click on the black and white box to the bottom left of the color selector.

---

#### Tip



Figure 4.9: Reverse Colors Button

To inverse the colors, click on the little arrow to the top right of the two boxes.

---



Figure 4.10: Default Line Width

---

To the right of the two squares are five lines of increasing width. To select the desired default line width, simply click on it. A dashed-rectangle indicates which width is currently selected.

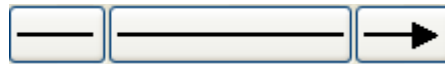

Figure 4.11: Arrow and Line Style

At the bottom of the Toolbox are three buttons. The left button allows you to select the default arrow shape for the beginning of a line. In the screenshot this is defaulting to "no arrow". The right button allows you to select the default arrow shape for the end of a line. Since only lines have arrows, these buttons only affect line objects and have no effect on other shapes. The middle button allows you to select the default line style (solid, dashed, etc.).

---

**Note**

The line-width and line style settings affect all basic objects. For shapes, these settings determine the line properties of the shape outlines. These settings also are used for some special objects (e.g., Flowchart objects). Other special objects (e.g., AADL objects) have fixed line widths and are not affected by these settings.

---

## 4.2 Using Objects

### 4.2.1 Adding Objects

Adding objects to the Dia canvas is done by clicking on the desired object's icon button in the Toolbox and then clicking on the canvas at the desired insertion point. The selected object will be inserted at that point.

---

**Tip**

You can quickly add multiple objects of the same type to the diagram using the Space key to toggle between the Modify control and the desired object. For example, say you wish to add several Box objects to the diagram. First, click on the Box icon and click on the canvas to add the Box. At this point, the Modify control will be selected automatically. To reselect the Box control, press the Space key. Now you can click on the canvas again to add a second Box object. Continue to press Space and then click to add as many Box objects as desired.

---

---

**Tip**

If you are using different colors or line styles for different objects, one trick to save time is to create a separate file of sample objects with the desired properties on a separate diagram. Then copy and paste these objects onto your working diagram as you need them.

---

### 4.2.2 Moving Objects

When an object is inserted into the canvas, the desired object will appear with small green boxes (known as handles) around the border.



Figure 4.12: Object Handles

To move an object, click anywhere inside the object (or somewhere on a line other than a handle) and drag the mouse to the desired location on the canvas. For line objects, you need to click on the line.

---

---

**Tip**

When moving an object, be sure not to click on a handle. Otherwise, you will resize the object instead of moving it.

---

### 4.2.3 Resizing Objects

Handles are used to change the size of the object. To expand an object, just click a handle and drag it away from the center of the object. To shrink an object, drag a handle toward its center. The object's size will change as you drag the mouse. If an object has a fixed aspect ratio, changing one dimension automatically changes the other. If an object has a free aspect ratio, you can change one dimension (e.g., height) without affecting the other (e.g., width). Some objects have a property setting that determines whether the aspect ratio is fixed or free.

### 4.2.4 Deleting Objects

To delete an object, click on the object to select it. The handles will display, which indicates that the object is selected. Then press the Delete key or select Edit → Delete from the menu.

### 4.2.5 Connecting Objects With Lines

In many diagrams, shapes are connected to each other using one of the basic line objects. When a shape is not selected, a number of connection points are displayed on its borders as small "x" figures. There is also a connection point in the middle of each shape. Lines also have connection points where other lines can connect.

Lines have handles on each end that are used to connect them to other objects. These handles are green if the line is not connected and red if it is connected. Lines also have orange handles that are used to shape the line. The figure below shows several lines with green handles on the unconnected end and red handles on the connected end.

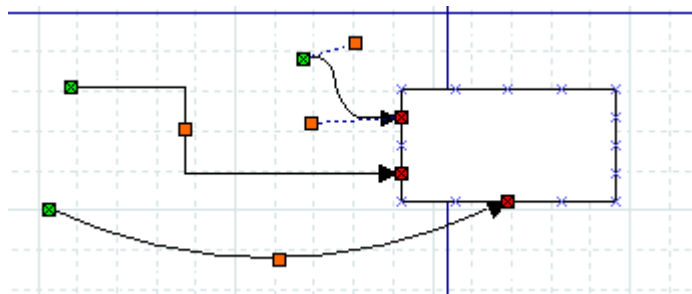

Figure 4.13: Line Handles

To connect two shapes with a line:

1. Select the desired line (Line, Zigzagline, etc.) by clicking on the Toolbox icon.
2. You can either click on the canvas to place the line on the diagram and then drag the "from" end of the line to the desired connection point of the first object.  
Or you can save a step by clicking directly on the desired connection point of the first object. In this case, the line will display with the "from" end of the line already connected to the first object.  
In either case, when the "from" end of the line is connected, it's "from" handle will be red.
3. Click on green handle at the "to" end of the line and drag it to the desired connection point on the second object. When the line is connected, the outline of the object being connected will turn red, as shown in the figure below.

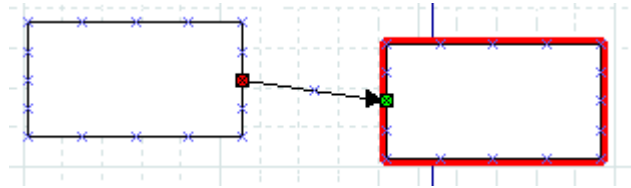

Figure 4.14: Line Connected

At this point, the two objects are connected. If you move either object, the line will stretch to keep them connected. If you move the line, it will disconnect from both objects. If you do this by mistake, you can undo using Ctrl+Z or Edit → Undo.

At any time, you can disconnect or connect to a new point by clicking on the "from" or "to" handle and dragging it to a new location on the diagram.

---

**Tip**

If you connect a line to a fixed point on a shape's perimeter, it will stay connected to this point when the object is moved.

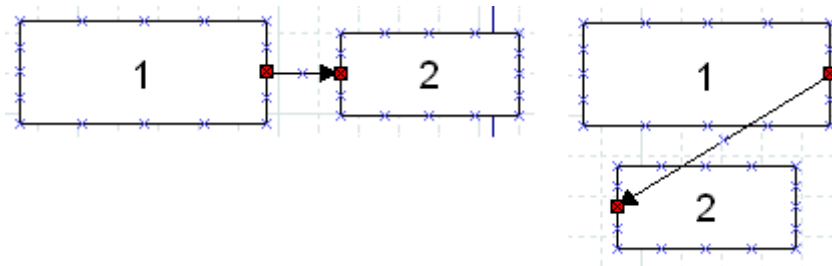

Figure 4.15: Fixed Connection Point

If you connect a line to the middle of an object, when you move the object the displayed connection point moves automatically, so you don't need to change the connection point.

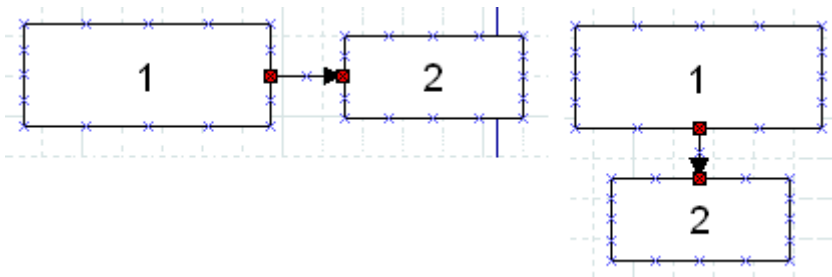

Figure 4.16: Middle Connection Point

Note that, when a line is connected to the middle of an object, the line's connection handle is still positioned on the perimeter of the object. So to move the line's connection point, drag on the line's handle (as opposed to the middle of the object).

---

**Tip**

If you connect a Line or Polyline object to the middle of a shape when you first place the line on the canvas, you need to be careful when connecting the "to" end of the line. Be sure to click on the line's handle and not on the surrounding area within the shape. If you click on the surrounding area inside the shape, you will select the shape and not the line's handle. If this happens, click outside the shape to deselect it and then carefully click on the "x" in the middle of the object (not on the line's arrow). The handle will display, and you can drag it to the desired location. Note that the handle will display as red, because it is connected to the middle. Also note that you need to drag it outside the shape before you can see the line.

See [Basic Objects / Line](#) for more information on the different lines available.

**4.2.6 Entering Text**

Text can be entered by selecting the object, entering text edit mode and then typing the text. The font, size, alignment, and other formatting properties can be changed by double-clicking the object, when not in text edit mode.

Many Dia objects support in-canvas editing of text. Dia versions before 0.97 had not explicit distinction between a selected object and its text edit mode. As a result numerous workarounds were needed to support canvas and text editing with the same set of keys, e.g. the Delete key was not deleting the character right to the cursor, but instead the whole object.

With Dia 0.97 and later there is a dedicated **text edit mode**. You can enter it by hitting Enter or F2 key while an appropriate object is selected. To leave text editing just click outside of the editable area or hit the Escape key.

Copy Text	
Cut Text	Shift+Ctrl+X
Paste Text	Shift+Ctrl+V

Figure 4.17: Edit Menu Text Commands

**Tip**

While in text edit mode the normal Copy / Paste keys (Ctrl+C, Ctrl+V) work on the entire text. The Edit menu also contains the commands Copy Text, Cut Text (Shift+Ctrl+X), and Paste Text (Shift+Ctrl+V) to copy, cut, and paste just the text contents of an object. Note that when you paste text into an object, the text is formatted according to the Dia object properties, not the text source.

**Tip**

You cannot select a section of text inside an object with the mouse (this moves the cursor). You can insert characters at the current cursor position just by typing. You can delete the character to the left of the mouse using Backspace. The Del key deletes the character right to the cursor. To delete all of the text in an object, use the Cut (Shift+Ctrl+X).

**4.2.7 Aligning Objects**

Dia provides several options to help arrange multiple objects without needing to move each object individually. These are available on the Objects → Align menu choice shown below.



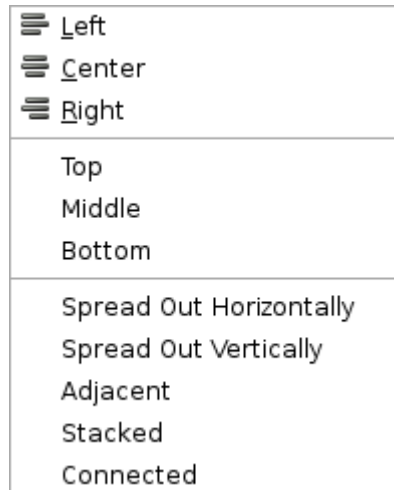

Figure 4.18: Objects / Align Options

#### 4.2.7.1 How To Align Objects

To align objects, first select the objects to align (see [Selecting Objects](#)) and then execute one of the align commands, using either the menu or the shortcut key. The order in which objects are selected does not matter.

#### 4.2.7.2 Left, Center, and Right Align

The align left, right, and center are used to align objects arranged vertically on the canvas. The align left aligns the selected objects to the left edge of the left-most object. Similarly, the align right aligns the selected objects to the right edge of the right-most object. Align center aligns the center of each object to the mid-point between the extreme left and extreme right edge of all selected objects. Examples of align left, center, and right are shown below.

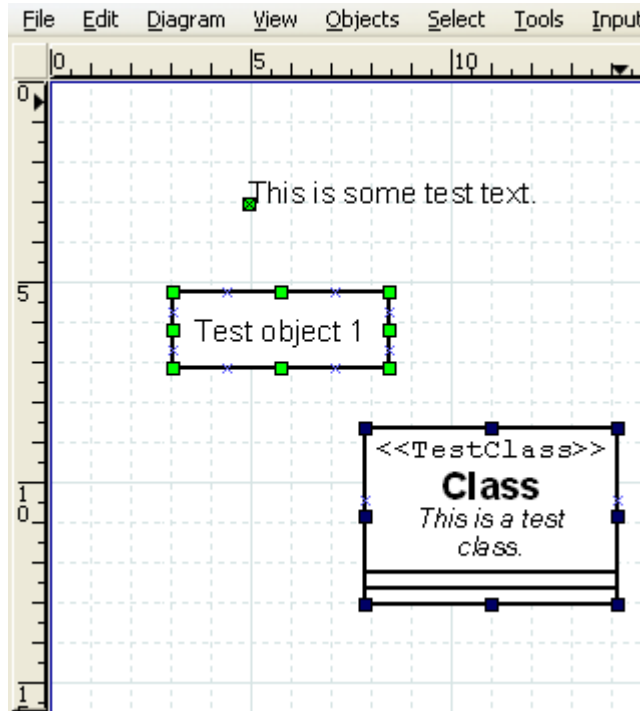

Figure 4.19: Before Left, Center, Right Align

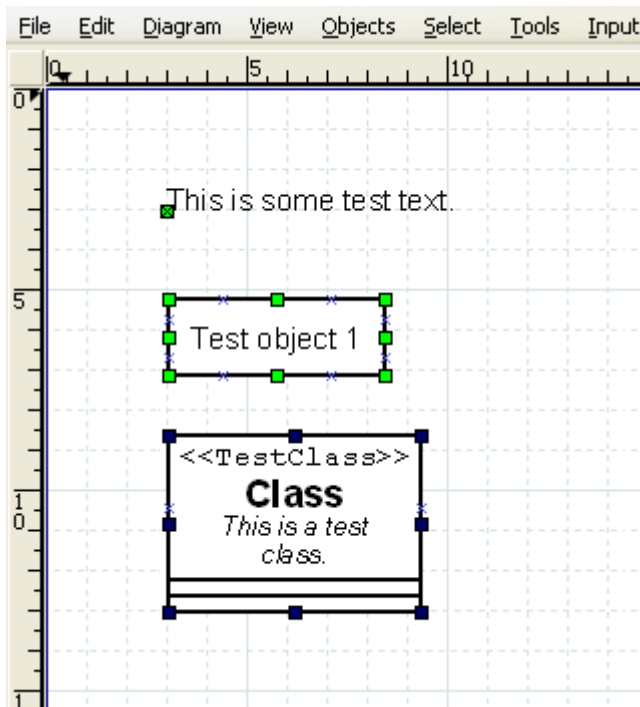

Figure 4.20: Align Left

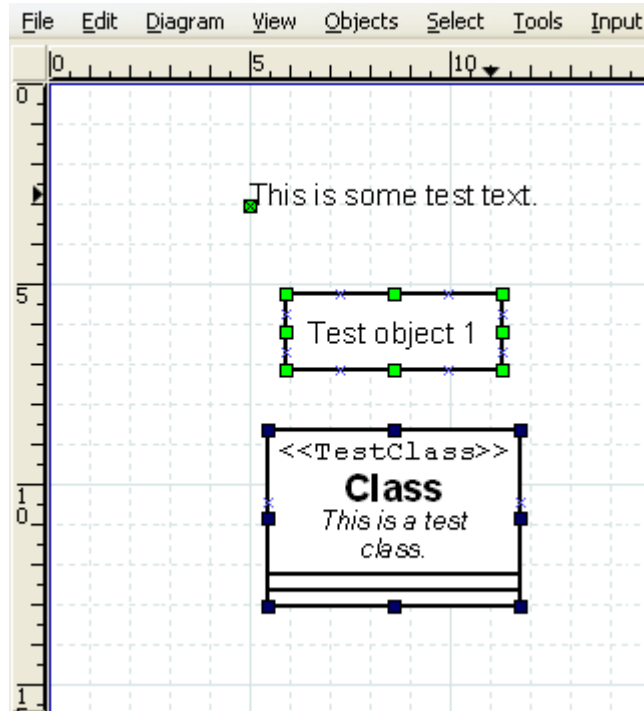

Figure 4.21: Align Center

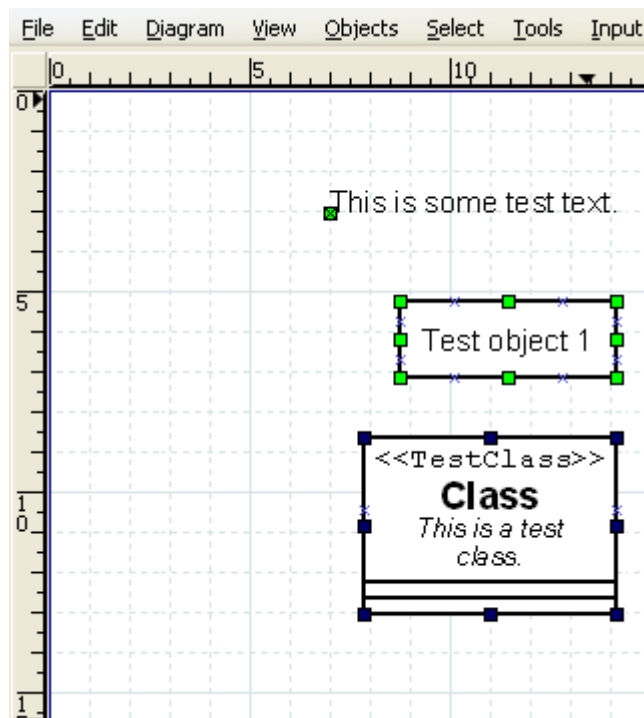

Figure 4.22: Align Right

### 4.2.7.3 Top, Middle, and Bottom Align

The align top, middle, and bottom are used to align objects arranged horizontally on the canvas. The align top aligns the selected objects to the top edge of the upper-most object. Similarly, the align bottom aligns the selected objects to the bottom edge of the lowest object. Align middle aligns the middle of each object to the mid-point between the extreme top and extreme bottom edge of all selected objects. Examples of align top, middle, and bottom are shown below.

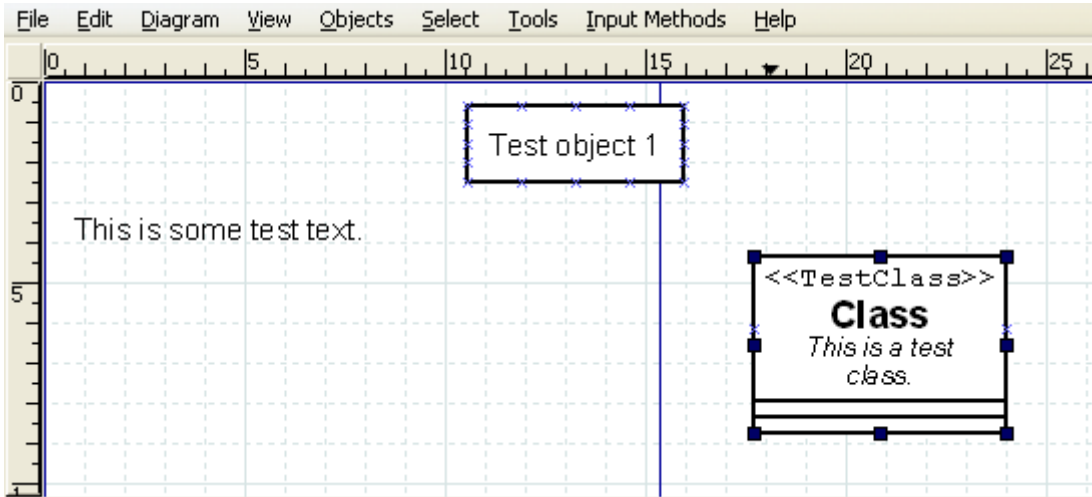

Figure 4.23: Before Top, Middle, Bottom Align

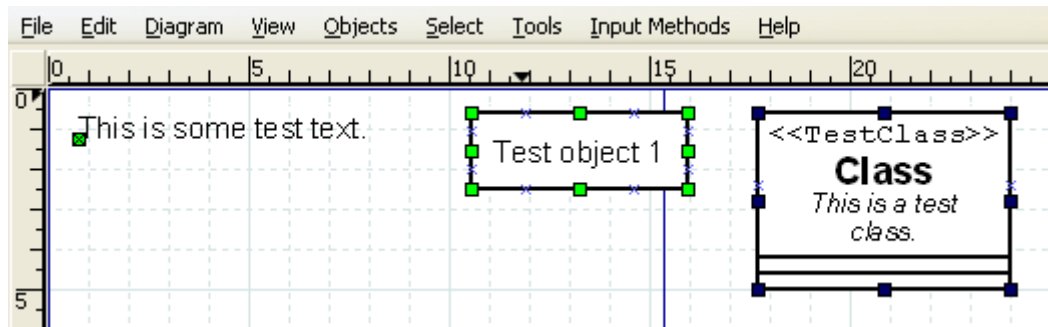

Figure 4.24: Align Top

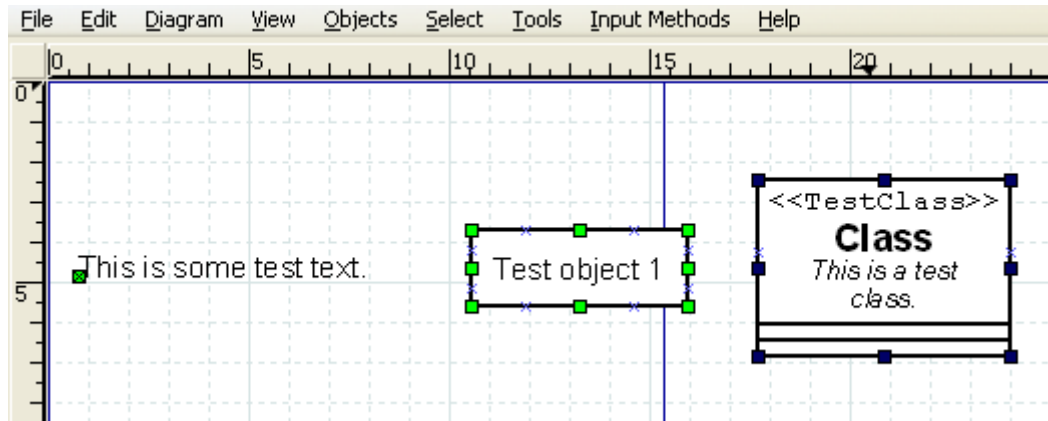

Figure 4.25: Align Middle

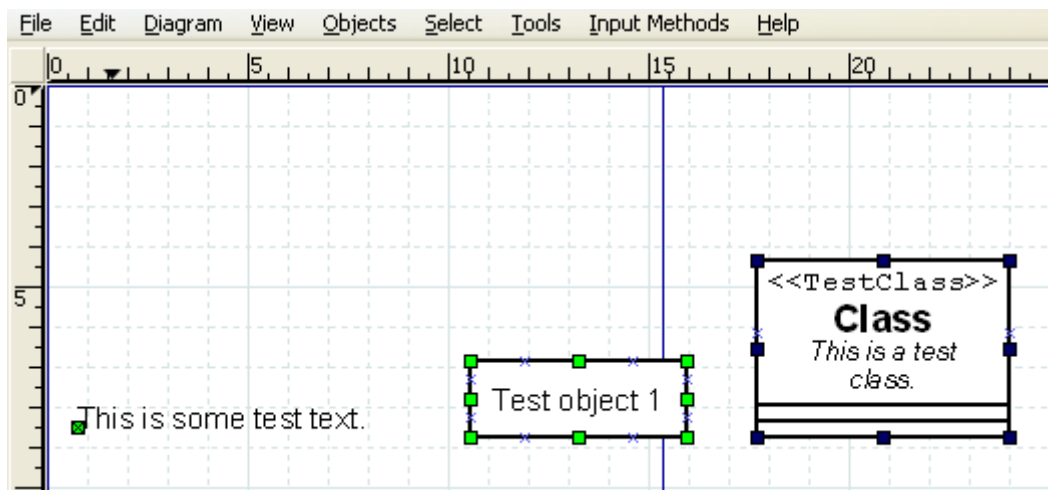

Figure 4.26: Align Bottom

#### 4.2.7.4 Spread Out Horizontally and Vertically

The Align / Spread Out commands can be used to create uniform spacing for objects arranged either horizontally or vertically. Examples of these commands are shown below.

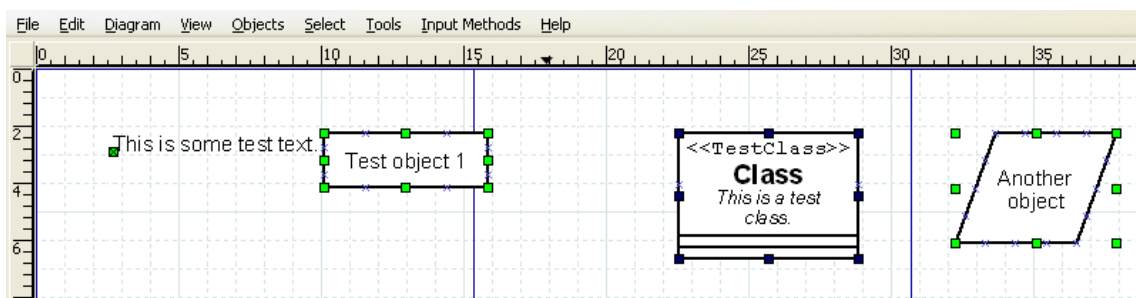

Figure 4.27: Before Spread Out Horizontally

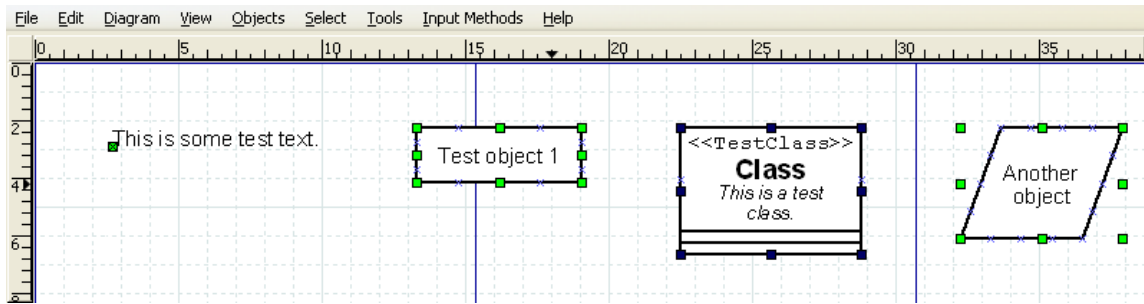

Figure 4.28: After Spread Out Horizontally

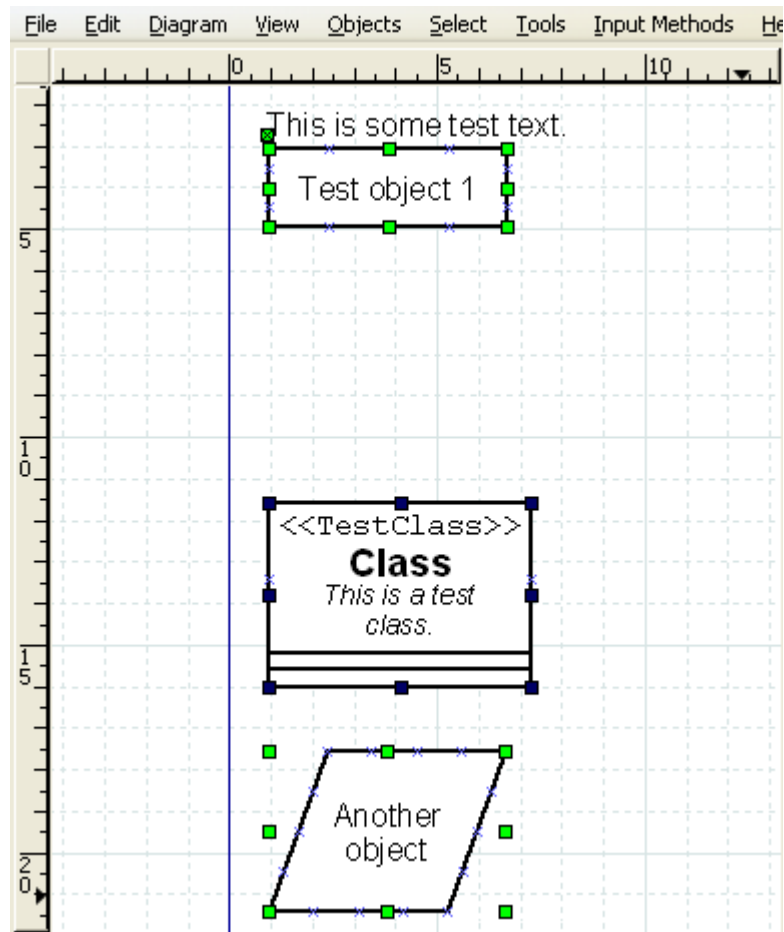

Figure 4.29: Before Spread Out Vertically

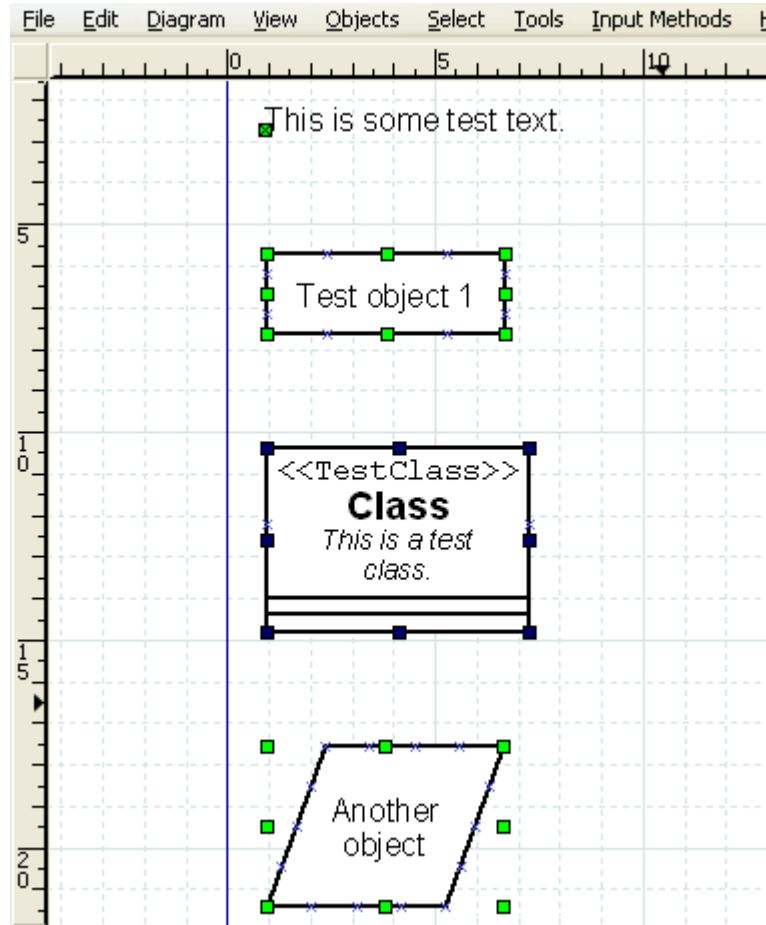

Figure 4.30: After Spread Out Vertically

#### 4.2.7.5 Align Adjacent or Stacked

The Align / Adjacent command is used to place objects next to each other with no horizontal space in between. The Align / Stacked is used to place objects directly on top of each other, with no vertical space in between. Examples of these commands are shown below.

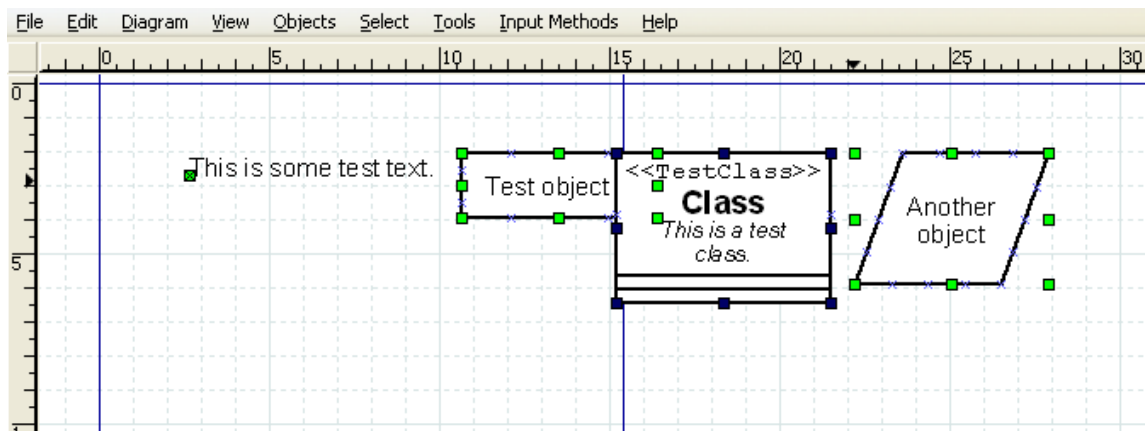

Figure 4.31: Align / Adjacent

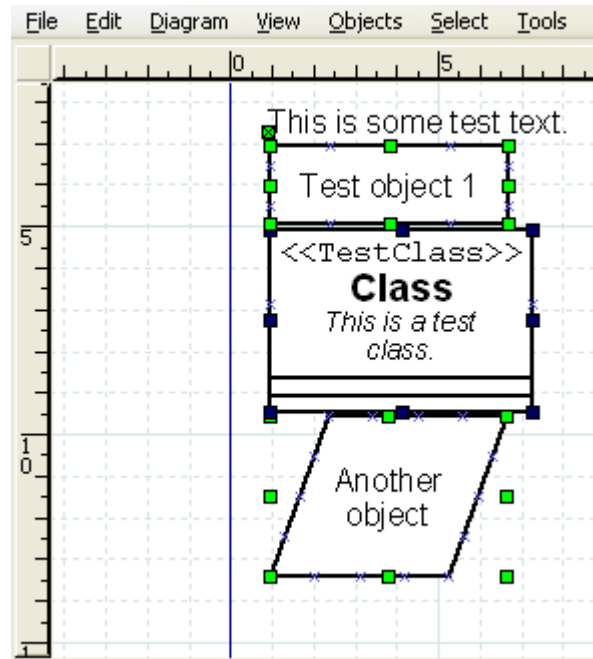

Figure 4.32: Align / Stacked

#### 4.2.7.6 Align Connected

The Align Connected command tries to align connected objects, so that the connecting lines are either horizontal or vertical afterwards.

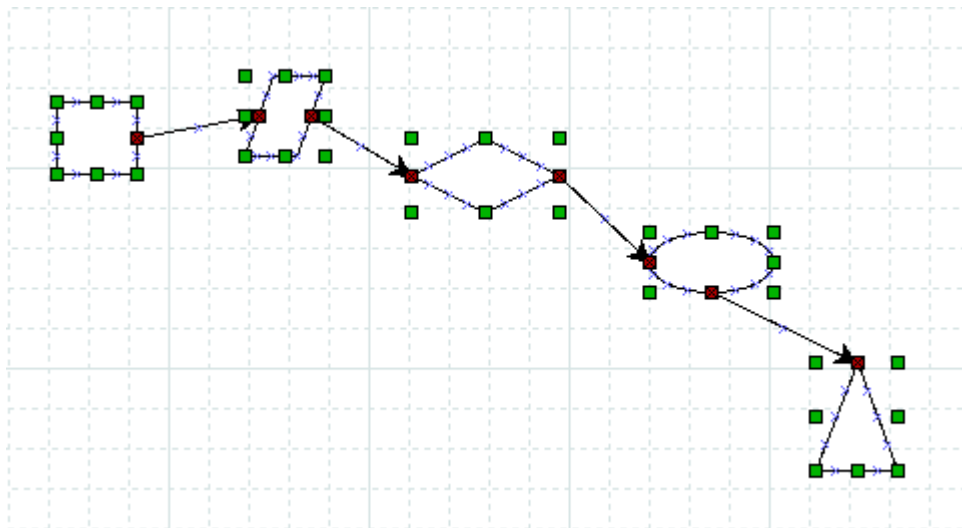

Figure 4.33: Before Align Connected



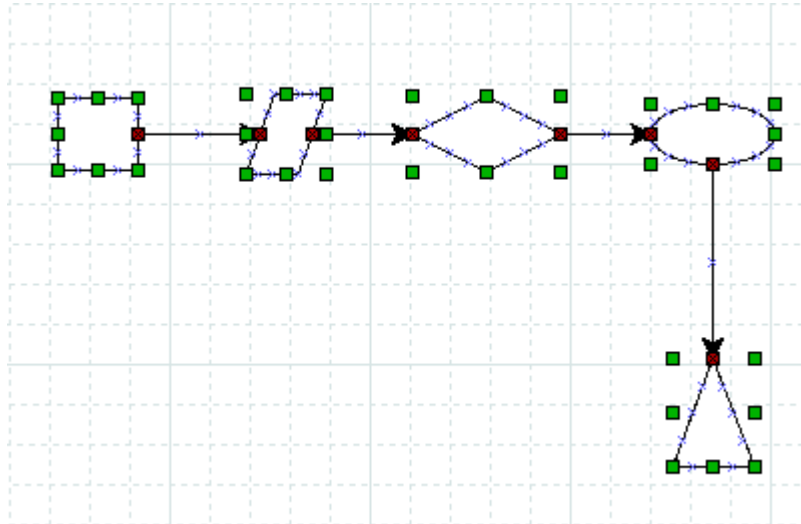

Figure 4.34: After Align Connected

**Note**

The algorithm used to align connected objects is not fool proof, infact it is very simple. If the resulting alignment does not match your expectations use Undo to revert it. A different selection of objects may producae a result more to your liking.

### 4.2.8 Grouping Objects

Grouping allows you to treat several objects as a single entity. A group enables you to fix the position of the member objects in relation to each other and to change the properties of all member objects at one time. To create an object group, select two or more objects and then select Objects → Group.

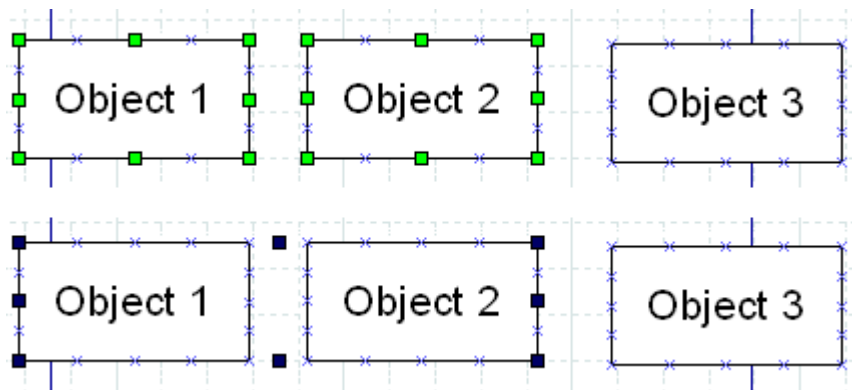

Figure 4.35: Before and After Group Create

When the group is created or subsequently selected, a set of black handles displays around the outside of the group, as shown in the figure above. At this point, you can move the entire group just like you would move a single object. Just click and drag on any of the objects in the group.

You can also change the properties of all objects in a group by double-clicking or using the right-click context menu. See [Changing Properties for a Group of Objects](#) for more information.

## 4.3 Object Properties

The properties of an object control its appearance. Properties include text font and appearance; line width, style, and color; transparency (i.e., draw background yes or no); foreground and background color; and any other settings that control the way an object is displayed. Different types of objects have different sets of properties.

The specific properties of an object are determined in two different ways. The default settings in force at the time the object is added to the canvas determine the object's initial properties. Once objects are placed onto the diagram, their properties may be set using the Properties dialog box for the object or for a group of objects.

### 4.3.1 Sources of Default Properties

An object's default properties are set in two places within Dia. First, as discussed above in [Default Color, Line Width, and Line Style](#), default values for the foreground and background color; the line width; and the line style of all basic objects and some special objects are determined by settings on the Toolbox. For basic lines, the default beginning and ending arrow styles are also determined by the Toolbox settings.

The rest of an object's default properties can be set using the Defaults: Properties dialog box for each object. This is opened by double-clicking on the object's icon on the Toolbox. Since the available properties for each type of object can be different, each object's default properties dialog is different. Below are examples of the default properties dialog for the basic Text and Box objects.

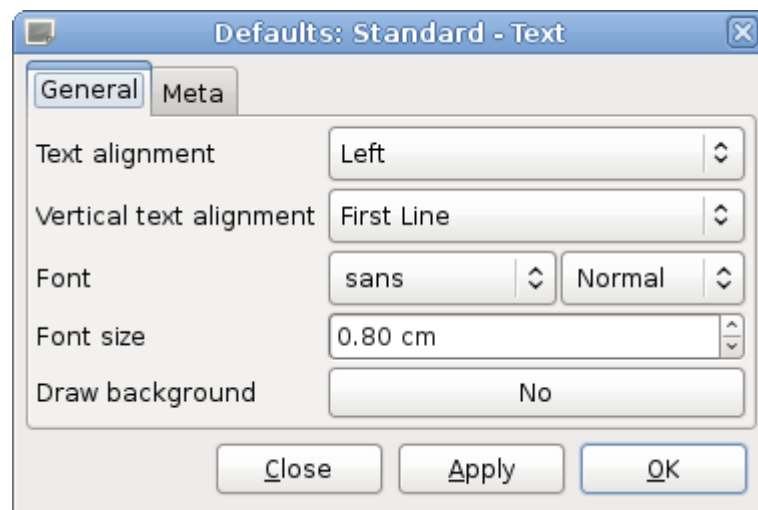

Figure 4.36: Default Text Properties

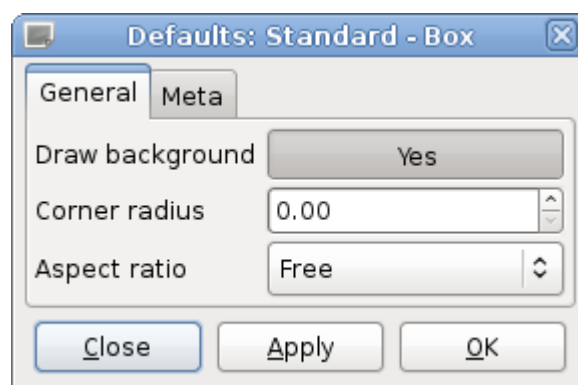

Figure 4.37: Default Box Properties

For objects that include text, the dialog will normally include the text alignment, the font name, the font modifier (normal, bold, etc.), and the font size (in centimeters, not points). This makes it possible to set defaults for text display for any object that can contain text.

## 4.3.2 Changing Object Properties

Once objects are placed onto the diagram, their properties can be changed either individually or as a member of a group.

### 4.3.2.1 Changing Properties for One Object

To change the properties of an individual object, either double-click on the object or select the object, right-click to display the context menu, and select the Properties option. In either case, the Properties dialog for the selected object will display, allowing you to change any of the object's properties.

---

#### Note

If multiple objects are selected, you can still change the properties of one of the selected objects by double-clicking that object. This will only change the properties of the one object you double-clicked.

---

### 4.3.2.2 Changing Properties for a Group of Objects

You can change the properties of a group of objects at one time by selecting two or more objects and then selecting Objects → Group to create a group. Once the group is created, you can set properties for all objects in the group. To do this, either double-click on the group or right-click to display the context menu and select the Properties option. The Properties: Group dialog will display. Only properties that pertain to all of the selected objects will display in the dialog. If your group contains only objects of one type, then all of the properties for that object type will display.

For example, if a group contains all basic Line objects, all of the Line properties will display in the Properties: Group dialog. If a group contains a basic Line and a basic Box, the Properties: Group dialog will only show Line width, Line color, and Line style, since these are the properties these objects have in common.

Changing properties for a group is a powerful feature of Dia. For example, say you have a large diagram and you need to change the line style of all the basic Line objects everywhere in the diagram. You can accomplish this easily with the following steps.

1. Select one basic Line object.
2. Use Select → Same Type to select all of the basic Line objects on the diagram.
3. Use Objects → Group to create a group for the selected objects.
4. Double-click on the group and make your property changes.
5. Use Objects → Ungroup to remove the group.

With this technique, you can quickly change the properties of many objects. This also works with selections containing multiple object types, as long as all of the selected objects have the properties you want to change.

## 4.4 Colors

All objects in Dia have color attributes. Lines have line color. Shapes have line color and fill color. Text and other objects that contain text have text color. In addition, the Diagram → Properties allows you to set colors for Background, Grid Lines, and Page Breaks. Finally, the Toolbox allows you to set default foreground and background colors for new objects.

In most cases, there are two methods for selecting a color. First, you can select a color from a list of colors provided in the drop-down listbox by each color property.

---

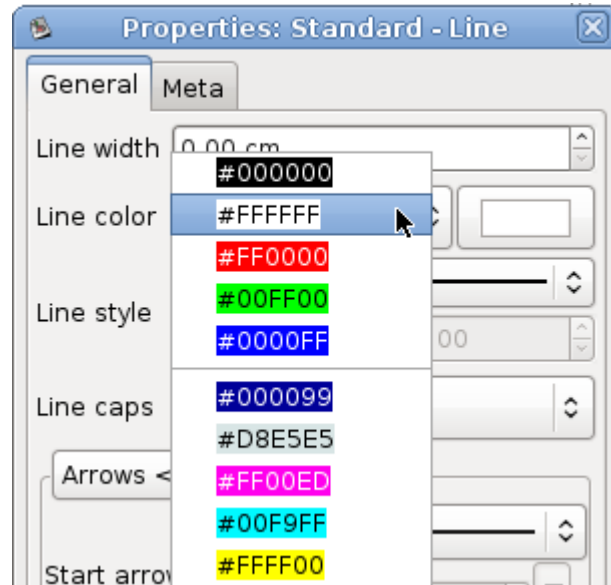

Figure 4.38: Color Listbox

The list contains five primary colors (black, white, red, green, and blue) plus custom colors that have been previously used. You can just select a color from the list or select "More colors..." to display the Select color box. The Select color box allows you to select any color. It is explained in the next section.

#### 4.4.1 Select Color Box



Figure 4.39: Select Color Box

The Colors selector box contains 7 zones:

1. The colors wheel allows you to select a color using the mouse. Select the color you want from the outer ring. A white or black line shows the current position on the ring. Select the darkness or lightness you want using the inner triangle. A white

or black circle shows the current position in the triangle. You can click or drag on either surface. The currently-selected color displays in the right side of the rectangle just below the circle.

2. Below the color wheel there are two rectangles. The left one displays the current color of the object, the right one the new color (i.e., the one you currently have chosen using the colors wheel). Pressing the OK button will set the object to the new color.

Just to the right of these rectangles, there is a pipette button. When you click this button, the mouse pointer changes to a pipette. When the pipette is active, you can click on the canvas or any open application window (Like The Gimp), and select any color!

---

**Note**

On Windows, you can only select from colors on the Dia canvas.

---

3. In the lower right there is a predefined color palette. Click on any of these to choose the color.
4. To control the transparency of the color you can use the slider in the middle right.
5. In the upper center there are settings for Hue, Saturation, and Value (HSV). You can select a color by typing a numeric value or by using the increment / decrement controls. Note that when you enter a value here, the color wheel selection changes to reflect the new color.
6. To the right, there are settings for Red, Green, and Blue. These work the same as the HSV controls.
7. In the middle of the box is a place to enter a Color name. This supports standard color names or HTML-style hexadecimal color values. (See [HTML4.01 colors on http://www.w3.org](http://www.w3.org)), and hexadecimal values (0-9A-F) on 3 or 6 octets.

## 4.5 Diagram Tree

The Diagram Tree provides an alternative method of working with a diagram. This window displays a list of all objects in the diagram in a scrolling list box. By right-clicking on an object, you can perform a number of operations.

### 4.5.1 Opening the Diagram Tree

The Diagram Tree is shown by selecting File → Diagram Tree from the Toolbox menu bar or by pressing F8 when the Toolbox is in focus.

### 4.5.2 Working With the Diagram Tree

Some actions on the Diagram Tree affect the diagram itself. By selecting objects in the tree, you can modify multiple of them at once. You can sort the objects in the tree by type or name. click on the respective table header. If you right-click on the Diagram Tree list, a context menu displays with three options.

---

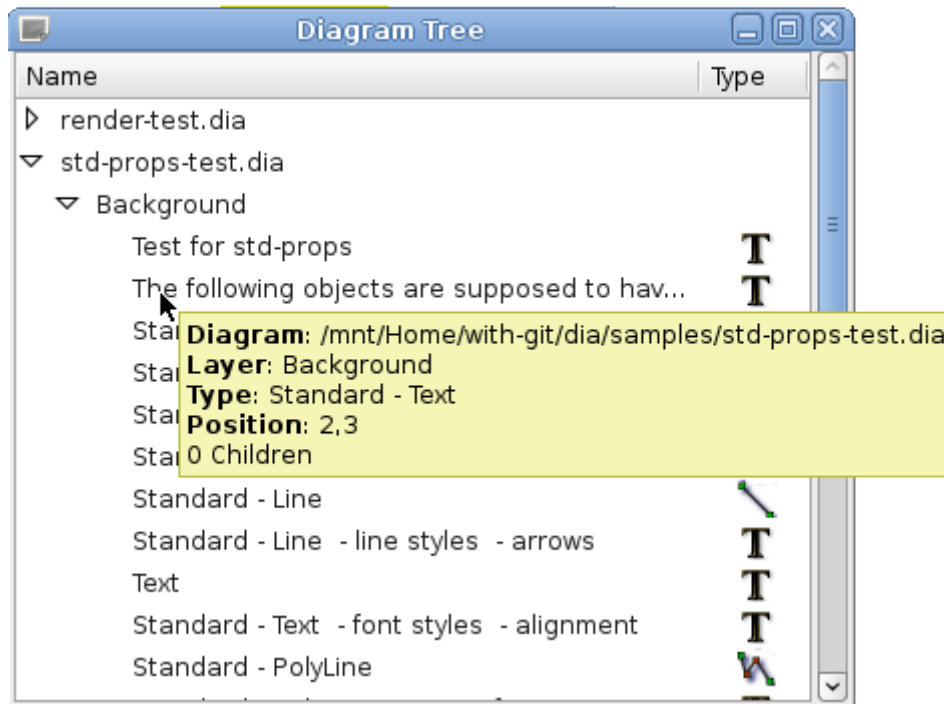

Figure 4.40: Diagram Tree

These options are explained below.

- Select will transfer the current the selection in the tree to the diagram.
- Locate will bring the selected object(s) into view on the canvas. This can be useful if you are trying to find an object in a large diagram.
- Properties will display the properties dialog for the selected object(s). See [Object Properties](#) for more information.

## Chapter 5

# Basic Objects

### 5.1 Basic Objects Introduction



Figure 5.1: Basic Objects

Dia has a dozen basic objects: Text, Box, Ellipse, Polygon, Beziernon, Line, Arc, Zigzagline, Polyline, Bezierline, Image and Outline.

#### 5.1.1 Text

Dia supports the use of text as its own type of object. Text can be placed on the canvas by clicking on the text button on the toolbox. For tips on editing text, see [Entering Text](#) in the Using Objects chapter.

---

**Note**

Text in Dia can use almost any font available in the system. But if you plan to exchange diagrams with people using a different platform, it would be smart to restrict yourself to a common subset.

---

The text object, and several other objects, offers direct text entry in the diagram. Text can be entered by selecting the object for [text editing](#) and then typing the text. The font, size, and other formatting properties can be changed by double-clicking the object.

---

Here are some important tips regarding short-cut keys when entering text.

- The normal Copy / Cut / Paste keys (Ctrl+C, Ctrl+X, Ctrl+V) don't work for text. They work for entire objects. Use Ctrl+Shift+X to cut and Ctrl+Shift+V to paste just the text in an object. There is no shortcut to copy just the text.

---

**Note**

When you paste text into an object, the text is formatted according to the Dia object properties, not the text source.

---

- You cannot select a section of text inside an object with the mouse (this moves the object). You can insert characters at the current cursor position just by typing. You can delete the character to the left of the mouse using Backspace.

---

**Note**

The DEL key used to delete the entire object, now it should work as expected: it either deletes the object or the text to the right of the cursor depending on the editing mode. If you delete something (text or object) by accident use Edit → Undo or Ctrl+Z if you delete an object by mistake.) To delete all of the text in an object, use the Cut (Ctrl+Shift+X).

---

- If you are using a non-default font or font size, one trick for productivity is to create a palette of empty objects with the desired font settings on a separate diagram. Then copy and paste these objects onto your working diagram as you need them (i.e., instead of using the Toolbox icons).

### 5.1.2 Box

The boxes in Dia can be customized to be any size desired by the user. The properties available are:

- Corner Rounding - Causes the corners to be rounded instead of hard edges.
- Draw Background - Keeps the center clear or fills with the background color.

### 5.1.3 Ellipse

An ellipse is a shape which has all rounded sides, such as a circle or an oval.

### 5.1.4 Polygon

A polygon is any closed shape made up of straight lines. The polygon tool, allows the user to draw any shape with all straight lines.

### 5.1.5 Beziergon

A beziergon is similar to the polygon as the user defines the shape. However, it differs in that it allows curves to exist in the shape.

### 5.1.6 Line

A Line is a simple straight line. Unlike the other lines, the simple Line does not have any handles to allow the shape to be altered. It just has two connection handles, one at each end.

### 5.1.7 Arc

An Arc is a line which has been bent to create a semi-circle shape. Drag the orange handle in the middle to alter the curve of the arc.

---



### 5.1.8 Zigzagline

A Zigzagline is a line which has sharp, 90 degree turns in it. Zigzaglines have two special properties, Corner radius and Autoroute. Corner radius allows you to round the corners of the line. On the Properties page, enter a number between 0 and 10.00, where 0 = square corners and 10.00 = maximally-rounded corners.

Autoroute is a yes/no property. If yes, the line is automatically routed between the start and end points with the minimum number of segments. If you move or change the shape of the line, the Autoroute property is automatically set to no. Autoroute can be set on the Properties page or using the right-click menu.

Zigzaglines also allow you to add or delete line segments. This can be useful if you need the line to turn several corners (e.g., to traverse around some other objects) or to get the arrow pointed in the right direction. To add or delete a segment, right-click on the line at the point on the line where you want to add or delete and select Add segment or Delete segment.

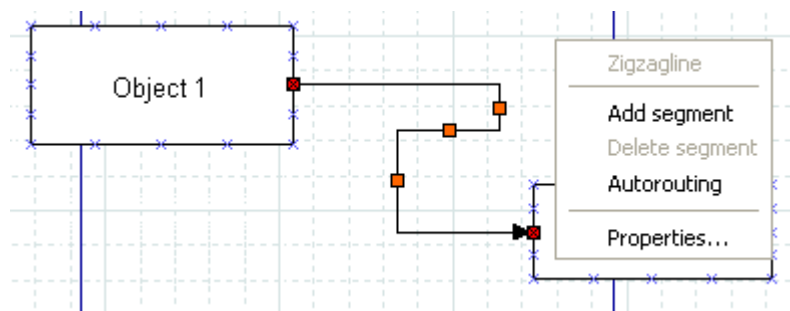

Figure 5.2: Zigzagline Right-Click Menu

### 5.1.9 Polyline

A Polyline has multiple segments like a zigzagline, but can have turns of any angle. A Polyline starts with one segment. You add more segments by right-clicking and selecting Add segment from the menu. Like the Zigzagline, the Polyline has a Corner radius value between 0 and 10.00, where 0 = sharp corners and 10.00 = maximally-rounded corners.

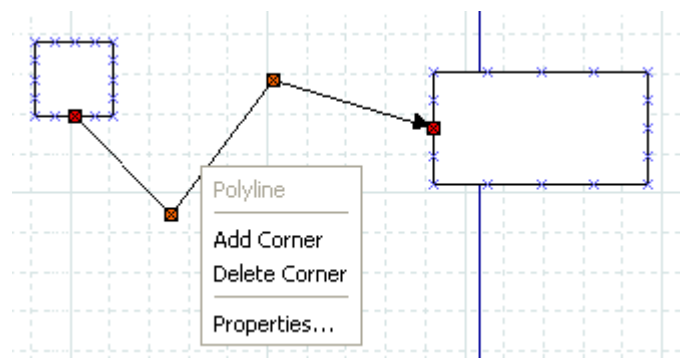

Figure 5.3: Polyline Right-Click Menu

### 5.1.10 Bezierline

A Bezierline is a line which has curves in it. The Bezierline's shape is edited by clicking and dragging the green and orange dots. The green dots customize the size while the orange dots customize the angles at which the line curves. With a right-click menu, you can add or delete segments. If you add one or more segments, three additional properties are available.

- Symmetric control causes any dragging action on the added segment to be symmetrical around this point.

- Smooth control allows you to pull away from the middle point independently but rotations around the middle point are symmetrical.
- Cusp control allows you to drag each handle independently, and actions on one handle have no effect on the other one.

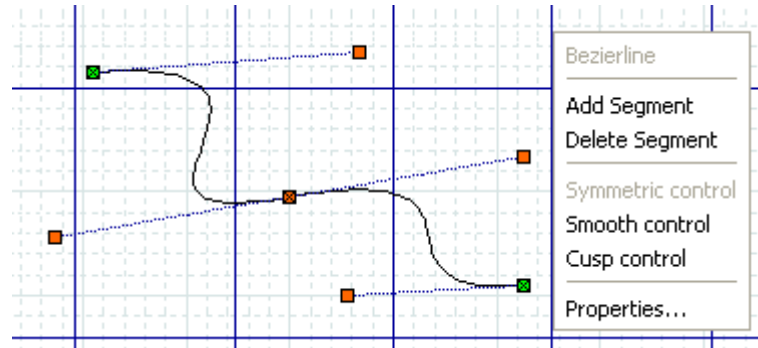

Figure 5.4: Bezierline Right-Click Menu

### 5.1.11 Line Properties

All lines share the following properties: width, color, style, and arrows. These properties may be edited using the Properties dialog box shown below.

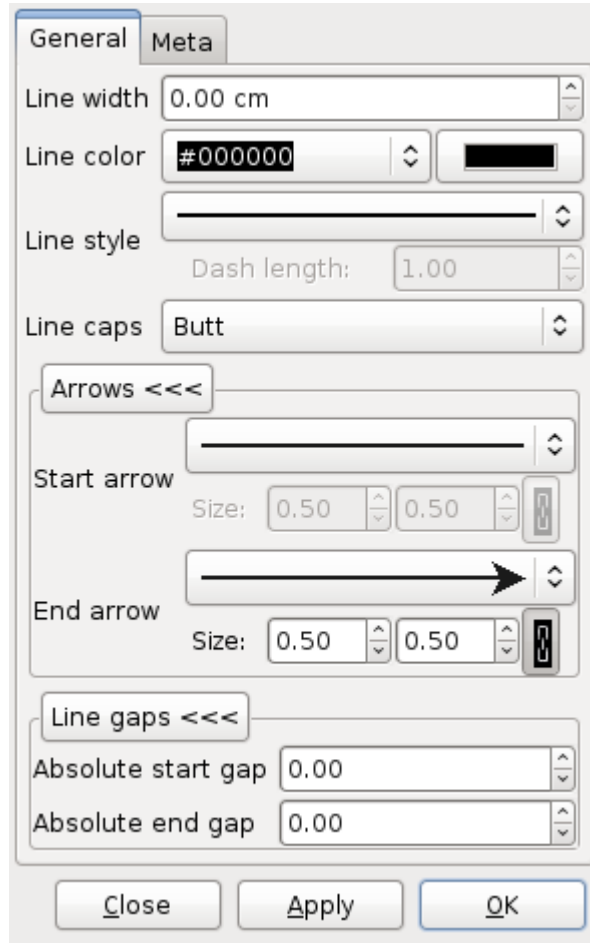

Figure 5.5: Standard Line Properties

### 5.1.11.1 Line Width

The line width is measured in centimeters and can be entered manually or by using the increment / decrement buttons.

### 5.1.11.2 Line Color

Line colors are edited by opening the Line color drop-down listbox and either selecting one of the choices on the list or "More colors...", which opens the Select color dialog. To change transparency you can also use the color button to the left of the color drop-down listbox. See [Colors](#) for more information on selecting colors.

### 5.1.11.3 Line Style

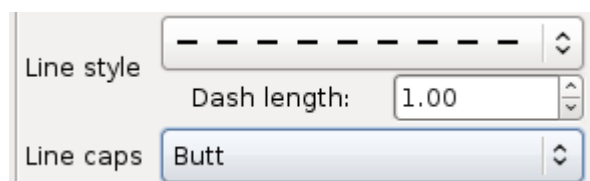

Figure 5.6: Line Styles

The style of the line (solid, dots, etc.) can be changed by using the Line style drop-down listbox. If you select a line style with dashes, you may also enter a dash length, measured in centimeters. The line caps can be changed by the respective combobox.

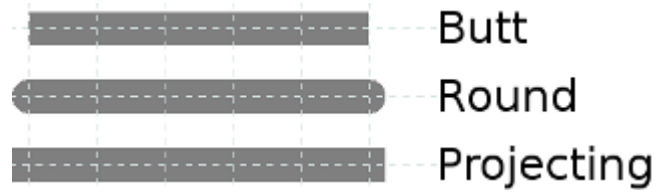

Figure 5.7: Line Caps

#### 5.1.11.4 Arrows

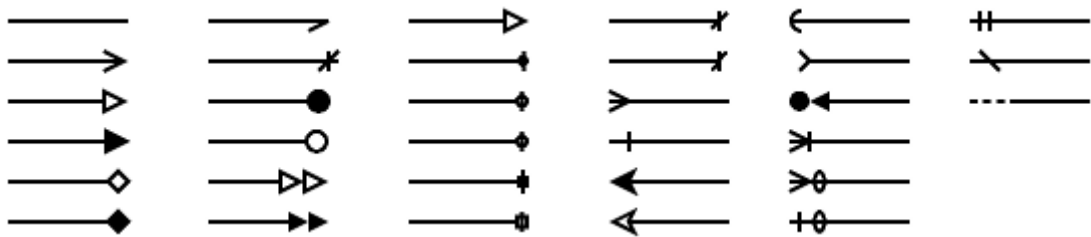

Figure 5.8: Line Arrows

The start and end arrow style can be changed using the drop-down listboxes in the dialog. A large number of options are available. If you don't want any arrow, just select the plain line at the top of the list.

#### 5.1.12 Image

A diagram can contain images as well as shapes. To add an image, click on the Image icon and click on the canvas. An object that says "Broken Image" will appear. Double-click it to open the properties dialog. Then click on "Browse" and select your file. Click "OK" and then the image will display on the diagram. You can resize the image as desired using the object handles.

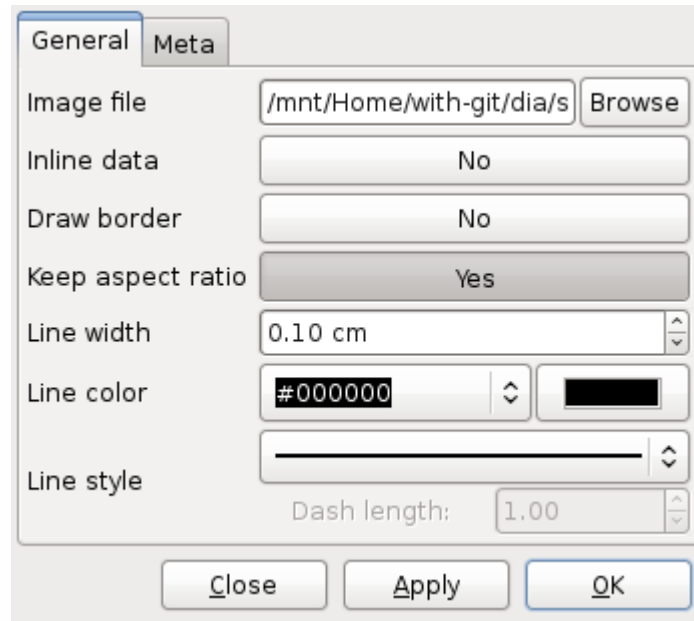

Figure 5.9: Image

The following image are usually supported for inclusion in Dia diagrams:

- BMP
- JPEG
- PNG
- SVG
- XPM

The exact list depends on your system configuration (the concrete import format filters available to gdk-pixbuf).

With Dia 0.98 there is an additional way to create image shapes. Choosing Edit → Paste Image will either update the image data in a selected image object or create a new image object containing the content of the clipboard.

---

**Tip**

Images can be stored embedded in the diagram ("inline data"). You should handle this option with care, because embedding images increases not only the files size, but also the load and save times for the diagram.

---

### 5.1.13 Outline

One of the most requested features for Dia is rotated text; shortly before having transformation capabilities for everything ;-). The Outline object is a small step in that direction. It has known limitations in convenience (you need to open the properties dialog to change the text) and rendering style (Dia's drawing model does not allow to **render holes**) with all supported renderers.

## Chapter 6

# Special Objects

### 6.1 Special Objects

Special objects are sets of objects designed to serve specific needs. They are organized into categories called sheets. The middle section of the Toolbox allows you to select a sheet of special objects. When you do this, the objects on this sheet display on the Toolbox and can be added to your diagram just like basic objects. Dia supports numerous predefined categories.

The predefined sheets are designed to group related objects together so you can see all of the objects you are likely to need on the same sheet. However, it is easy to modify the predefined sheets. See [Organizing Sheets and Objects](#) for more information.

It is also possible to create your own objects and sheets without programming. Custom shapes can be created with an XML file that describes the shape. See [Custom Shape Module](#) for more information on custom shapes.

#### 6.1.1 Special Object Categories

##### 6.1.1.1 Assorted

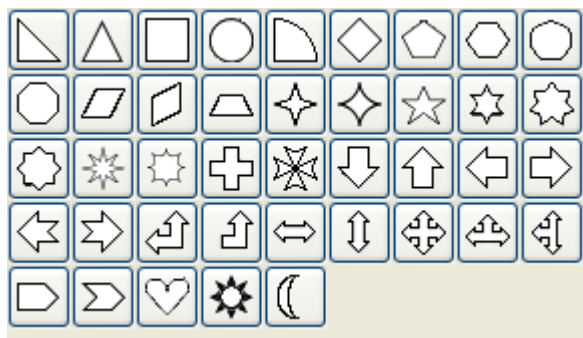

Figure 6.1: Assorted

Assorted Geometric Shapes. The purpose of this sheet is to provide a selection of simple and convenient preset shapes so that users need not create spend time creating their own basic shapes. The set includes shapes with constrained ratio such as perfect Circles, Squares, various type of Triangle and Crosses. These objects do not allow text to be entered inside the shape.

##### 6.1.1.2 Chemical Engineering

A collection of shapes for modeling the process of Chemical Engineering.

### 6.1.1.3 Chronogram

Uses objects to be used in a chronographic design. These are common place in time lines.

### 6.1.1.4 Circuit

A group for people interested in creating diagrams of electrical circuits.

### 6.1.1.5 Cisco - Computer



Figure 6.2: Cisco - Computer

Cisco - Computer includes shapes representing computer equipment from Cisco, a manufacturer of Computer Networking Equipment.

### 6.1.1.6 Cisco - Misc



Figure 6.3: Cisco - Misc

Cisco - Misc includes miscellaneous shapes from Cisco, a manufacturer of Computer Networking Equipment.

### 6.1.1.7 Cisco - Network

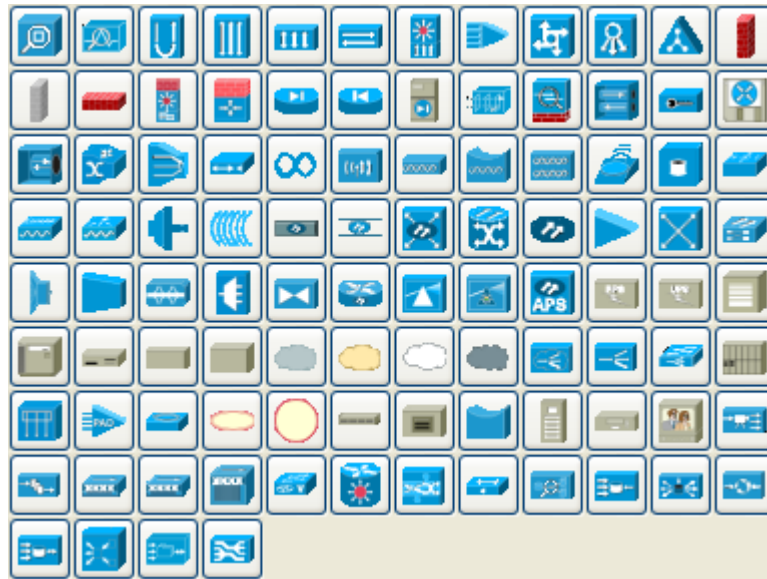

Figure 6.4: Cisco - Network

Cisco - Network includes shapes representing network equipment from Cisco, a manufacturer of Computer Networking Equipment.

### 6.1.1.8 Cisco - Switch



Figure 6.5: Cisco - Switch

Cisco - Switch includes shapes representing switch equipment from Cisco, a manufacturer of Computer Networking Equipment.



### 6.1.1.9 Cisco - Telephony



Figure 6.6: Cisco - Telephony

Cisco - Telephony includes shapes representing telephony equipment from Cisco, a manufacturer of Computer Networking Equipment.

### 6.1.1.10 Civil

Civil Engineering components.

### 6.1.1.11 Cybernetics

Shapes for creating diagrams of Cybernetic Circuits.

### 6.1.1.12 DIN Electrical

DIN style electrical control schematics (electrical controls in manufacturing automation).

### 6.1.1.13 ER

Editor for Entity Relations (ER) Diagrams. Entity Relationship diagrams are used to represent high level descriptions of conceptual models in terms of how each data entity relates to other data in the model. They are most commonly used to model the structure of data to be stored in a database.

### 6.1.1.14 Flowchart



Figure 6.7: Flowchart

A group dedicated to providing the user shapes which are commonly used in flow charts. Flow charts can be routinely found in computer programming, marketing, economics, and any other semi-linear operation which requires planning. Most flowchart objects allow entry of text.

### 6.1.1.15 FS (Function Structure)

Editor for Function Structure (FS) Diagrams. Note that the Objects require the use of the context menu to access much of the functionality of these objects.

### 6.1.1.16 GRAFCET

Grafcet (or IEC 61131-3 SFC) diagrams. Used in graphical programming and documenting sequential processes in manufacturing automation.

A chart shows the step, the action, the transition, and the condition associated with the transition.

### 6.1.1.17 Istar

Istar is agent-oriented modeling framework. Istar is also written as i\*.

### 6.1.1.18 Jackson

Jackson Software Design (JSD) method Diagrams.

### 6.1.1.19 KAOS

KAOS Diagrams.

### 6.1.1.20 Map 3D Isometric

Pseudo 3D isometric shapes for creating Directional Maps. Microsoft Visio calls these shapes Map, Directional Map 3D.

### 6.1.1.21 Misc.



Figure 6.8: Misc

Miscellaneous shapes that do not fit into any of the other groups. Includes some File system shapes and an animated clock object that updates in real time.

### 6.1.1.22 MSE

Mobile Subscriber Equipment Components, as used by the United States Army.

### 6.1.1.23 Network

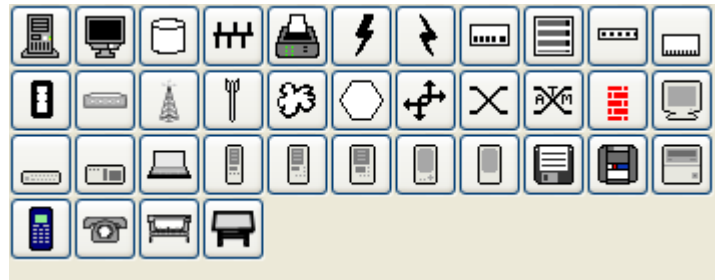

Figure 6.9: Network

Used by network administrators to create a design of their network.

### 6.1.1.24 PLC Ladder

PLC 'Ladder' graphical programming (electrical controls in manufacturing automation).

### 6.1.1.25 Pneumatic/Hydraulic

Allows diagramming of a device which employs hydraulics.

### 6.1.1.26 SADT

Structured Analysis Design Technique.

### 6.1.1.27 SDL

Specification and Description Language (SDL) SDL is used to describe the behavior of interactive time based systems. SDL was originally focused on telecommunication systems, but has also come to be used to describe process control and real-time applications in general.

### 6.1.1.28 Sybase

Designs diagrams display the flow of a Sybase computer network.

### 6.1.1.29 UML

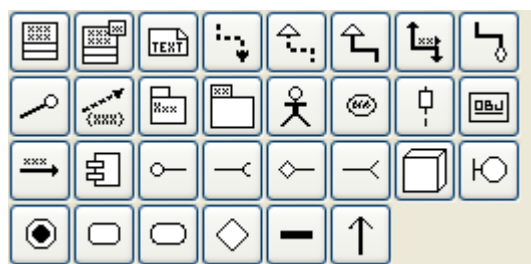

Figure 6.10: UML

Unified Modeling Language (UML). UML is a modeling and specification language commonly used to create diagrams showing the structure of object-oriented computer programming code, particularly for large scale projects. Some UML objects are complex and have extensive properties for various types of text entries, as shown in the screenshot below.

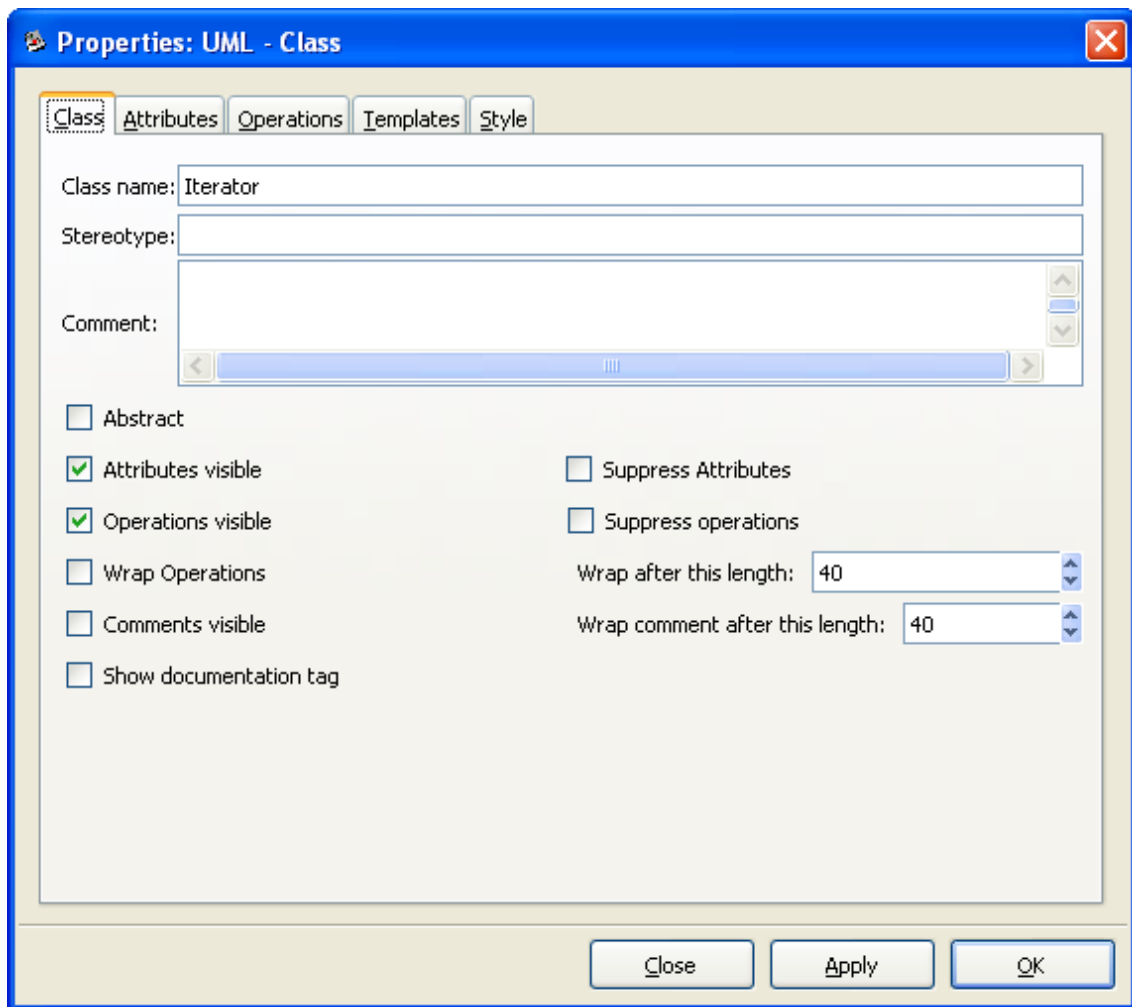

Figure 6.11: UML Class Properties

### 6.1.2 Organizing Sheets and Objects

It is possible to modify the way objects are grouped into sheets. Say, for example, that most of the object you need are on one sheet but you also need some objects from a second sheet. To keep everything you need on one sheet, you can copy objects from one sheet to another as follows:

1. On the Toolbox menu, select File → Sheets and Objects. This will display the dialog shown in the figure below.

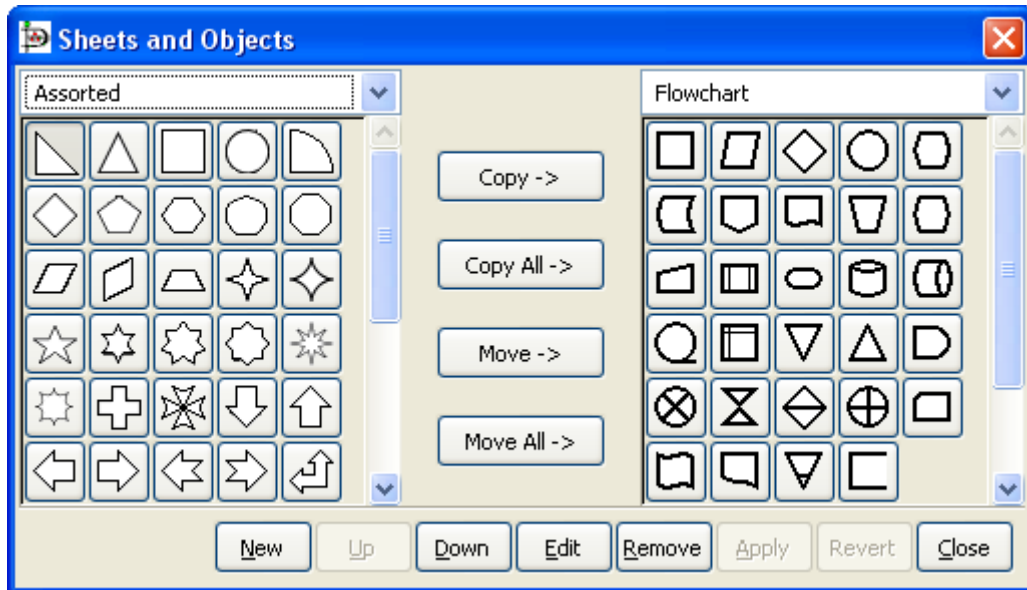

Figure 6.12: Sheets and Objects

2. Using the drop-down listbox on the left side, select the sheet you want to copy from. On the right, select the sheet you want to copy to.
3. Click on the object you wish to copy on the left side and press the Copy button.
4. Repeat for any other objects you want to copy. When you are done, press the Apply button on the bottom to save your changes.

From now on, the new objects will be listed on the sheet on the right. You can also remove objects from sheets and move objects from one sheet to another. You can also use the Up and Down buttons to change the order of the objects within a sheet.

## Chapter 7

# Selecting Objects

### 7.1 Selection Introduction

Selecting one or more objects is a very common task when using Dia. Whenever you wish to move, copy, delete, or edit an object or change its properties, you must first select it. You can also work with a set of selected objects -- for example, to move a group of related objects while keeping their relative positions intact or to change the properties of a group of objects.

Selecting objects can be done in several ways, including clicking with the mouse, selecting by area, or using the Select menu to perform additional selection options.

### 7.2 How To Select Objects

#### 7.2.1 Selecting a Single Object

To select a single object, just click it with the mouse. Also, when an object is first placed on the canvas, it is automatically selected.

Once an object is selected, its handles are illuminated. For shapes, the handles are green points on its corners and sides. For a line, the handles are green or red at the ends, and orange in the middle. Once the object is selected, you may work with it as desired. To access the object's properties, you can double-click it or right-click and select Properties from the pop-up menu.

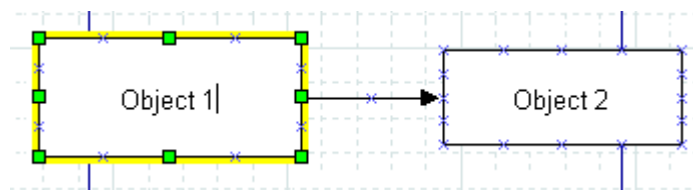

Figure 7.1: Selected Object

#### 7.2.2 Deselecting Objects

You can deselect one or more selected objects by double-clicking on any empty space on the canvas or by selecting any other object. The handles will disappear, indicating that the object is no longer selected. Selecting the Layers option from the Diagram menu will also deselect all selected objects.

### 7.2.3 Selecting Multiple Objects

Multiple selection is useful when you want to apply the same operation to two or more objects. When selected, you may work with these objects as a set or individually. See the section [Working With Selected Objects](#) for more information.

Dia provides a number of ways to select multiple objects. These are outlined below. Note that either double-clicking on an empty region of the canvas or single-clicking on an unselected object deselects all selected objects.

#### 7.2.3.1 Shift+Click Selection

A simple way to select two or more objects is to hold the Shift key down while clicking the objects with the mouse. The Shift+Click acts as a toggle. If you Shift+Click once, the object is selected. Shift+Click a second time to deselect the object.

---

**Tip**

You can combine Shift+Click with any of the other methods outlined below to either select an additional object or deselect a selected object.

---

**Note**

When you have a set of objects selected, it is still possible to resize or change the properties of one object without affected the other selected objects. See the section [Working With Selected Objects](#) for more information.

---

#### 7.2.3.2 Select By Area

You can select all of the objects within a rectangular region of the screen by placing the mouse pointer to the upper left of the top-left object in the set and then dragging the mouse to a point below and to the right of the lower-right object in the set. A thin dashed rectangle will be drawn on the canvas as shown in the screenshot below. All objects that COMPLETELY FIT inside this rectangle are selected. Objects that are only partly inside the rectangle are not selected.

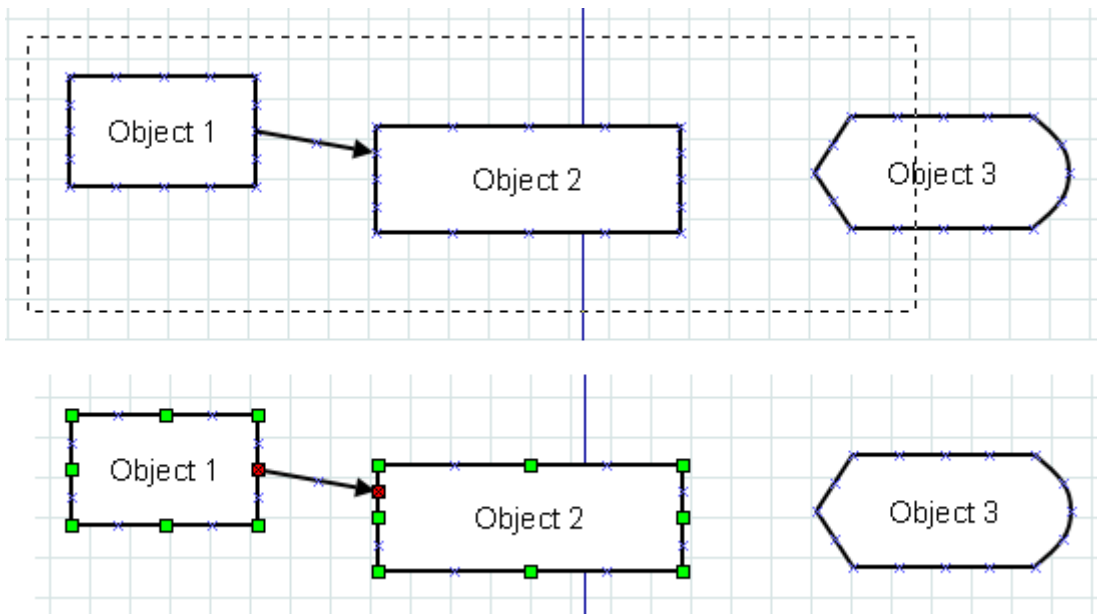

Only objects entirely inside rectangle are selected.

Figure 7.2: Select By Area Example

---

**Tip**

You can select multiple regions using select by area. Objects previously selected will continue to be selected as long as you don't deselect all (e.g., by double-clicking on an empty region of the canvas or by clicking on an unselected object without using the Shift key). As noted above, you can also use Shift+Click to select or deselect an individual object at any time.

**Tip**

Normally, selecting from top-left to bottom-right is the same as a "reverse drag" -- starting on the bottom-right and dragging toward the top-left. However, you can set an option in Dia that allows you to select objects that are only partially contained in the selection rectangle when you "reverse drag". See [User Interface / Reverse Dragging](#) for more information.

**7.2.3.3 Select All**

The Select menu shown below has six options for selecting multiple objects. The first option is All.

Select	Tools	Input Methods
All		Ctrl+A
None		
Invert		Ctrl+I
Transitive		Ctrl+T
Connected		Shift+Ctrl+T
Same Type		

Figure 7.3: Select Menu

You can select all objects on the canvas using the Select → All option or by pressing Ctrl+A. This selects all objects whether they are visible or not.

**Note**

As with any of the selection methods, if you are using layers, only objects in the current layer will be selected. See [Managing Layers](#) for more information on working with layers.

**7.2.3.4 Select None**

Select → None option will deselect all objects. It has the same effect as double-clicking on a blank region of the canvas.

**7.2.3.5 Select Invert**

This option allows you to select all objects except for those currently selected. Say, for example, that you have 20 objects and wish to select all but two of them. You can do this by (1) selecting the two objects to be excluded and then (2) using the Select → Invert menu (or Ctrl+I). This will deselect the two currently-selected objects and select the 18 unselected objects.

**Tip**

Another way to do this is to Select → All (or Ctrl+A) and then use Shift+Click to deselect the objects you don't need.



### 7.2.3.6 Select Transitive

Objects in Dia can be connected using lines. The Select Transitive and Select Connected options allow you to select objects based on how they are connected.

The Select Transitive option selects ALL objects connected directly or indirectly to the currently selected objects, no matter how many levels deep the connection might be. To use this, select one or more objects and then choose Select → Transitive. All objects connected to the initially selected objects will be added to the selected set.

### 7.2.3.7 Select Connected

This option is similar to Select Transitive except that it only adds objects that are immediately connected to an already-selected object. To use this option, first select one or more objects. Then choose Select → Connected. Any objects that are directly connected to the currently selected objects will be added to the selected set.

---

#### Note

The Select Connected option only goes out one level. For example, if box A is connected by a line to box B, and box A is selected, Select → Connected will only select the line, not box B. If you do Select → Connected a second time, then box B will also be connected.

You can use Select → Transitive to select all objects connected to the currently selected objects in one operation.

---

### 7.2.3.8 Select Same Type

This option allows you to select all objects that are the same type of object as one already selected. To use this option, select one or more objects and then choose the Select → Same Type option. All objects that are the same type as one of the previously selected objects will be added to the set of selected objects.

For example, if you want to select all of the Line objects on your diagram, select one Line object and then use Select → Same Type to select all other lines.

---

#### Tip

The menu choice Select → Same Type can be combined with the menu choice Objects → Group to quickly change one or more properties of all objects of one type on your diagram. See [Changing Properties for a Group of Objects](#) for more information.

---

#### Note

The object type must match exactly. For example, a Line object and a Zigzagline object are different types.

---

## 7.3 Working With Selected Objects

Once you have a set of selected objects, there are several things you may do with them.

### 7.3.1 Operations on All Selected Objects

The following operations can be done on all selected objects as a set.

#### 7.3.1.1 Move Selected Objects

You can move selected objects as a group, without changing their relative positions. To do this, place the mouse pointer inside a shape or on a blank spot on a line that is part of the selected set and then drag to the desired new location.

---

### 7.3.1.2 Copy, Cut, Paste, Duplicate, Delete

You can perform any of the normal edit operations on a set of selected objects, just as you would for a single object, using either the shortcut key or the Edit menu. For example, to Duplicate a set of selected objects, select Edit / Duplicate or press Ctrl+D. A copy of the entire set of objects will be created on your canvas, just below and to the left of the original objects. Note that when you Duplicate or Paste a set of objects, after the operation only the newly-created objects are selected.

### 7.3.1.3 Working With Individual Objects

Due to limitations in the implementation some operations on single objects in a selection were still only modifying the single object. Since dia 0.97 these inconsistency got resolved so the properties dialog allows to change multiple objects properties at once - without first grouping them.

Also the single objects handles change behaviour in a selection (shown by slightly dimming them). Instead of resizing the single object they can just be used to move the whole selection and align it on the grid, see [snap to grid](#) for details.

---

**Tip**

When pulling up the properties dialog, be sure not to double-click on the blank canvas or all of the objects will be deselected.

---

### 7.3.1.4 Creating an Object Group

As noted above, it is easy to create and remove sets of selected objects, and a selection can be removed accidentally by double-clicking on a blank area of the canvas. If you wish to keep a set of selected objects as a permanent group so that you will not accidentally deselect them, you can create an object group. Just select Objects → Group to create the group. You can select Objects → Ungroup to remove the group. See [Grouping Objects](#) for more information on groups.

## Chapter 8

# Loading and Saving Diagrams

### 8.1 Loading and Saving Introduction

Dia follows the saving model common to most desktop applications: you must explicitly save any canvases that you wish to retain for future use. To save a file, choose File → Save from the Main Popup Menu. The result is a standard save dialog. Your canvas is saved in Dia XML format. No file extension is automatically added, so it is a good idea to explicitly add '.dia' to the name you enter.

To load a canvas from a file previously saved by Dia or created by another application, select File → Open... from the Main Menu Bar. The result is an open dialog; select the file you want and choose Open. The open dialog is standard apart from the popup menu labeled Determine file type. Choose the format of the file to open (Dia XML or Drawing Interchange) if Dia does not correctly determine the file format unassisted.

An alternate file-loading method is to start Dia from the command line with the name of the file to open given as an argument.

### 8.2 File Types

A few words on file types are in order. You should be aware that not all format of files can be re-loaded into Dia after saving and that most supported file formats lose information to some degree.

#### 8.2.1 Dia Native Diagram Files

The only format guaranteed to be lossless is Dia XML. Happily, you are unlikely to accidentally save in a lossy format because File → Save always produces a file in Dia XML format.

Files in Dia XML format are automatically compressed using gzip to save disk space. This is almost necessary since, without compression, even simple diagrams are very large because they store much redundant information. Dia XML files are already compressed, so further compressing them using other archive formats will not help make them significantly smaller.

#### 8.2.2 Import/Export Formats

Dia is able to import and export the following file types:

- Scalable Vector Graphics (.svg)
  - AutoCad Drawing eXchange Format (.dxf)
  - Visio XML File Format (.vdx)
  - XFig File Format (.fig)
  - GdkPixbuf bitmap graphics (.bmp, .gif, .jpg, .png, .pnm, .ras, .tif)
-

### 8.2.3 Exporting Only Formats

Dia supports exporting to many other types of file, such as:

- Computer Graphics Metafile (.cgm)
- Dia Shape File (.shape)
- HP Graphics Language (.plt, .hpgl)
- Encapsulated Postscript (.eps, .epsi)
- Postscript (.ps)
- Portable Document Format (.pdf)
- Portable Network Graphics (.png)
- TeX Metapost macros (.mp)
- TeX PSTricks macros (.tex)
- WordPerfect Graphics (.wpg)
- XFig format (.fig)
- XSLT (eXtensible Stylesheet Language Transformation) (.code)

Dia cannot load files in most of these formats. These formats are useful for diagrams that you need to use in another application or to distribute to users of another operating system that Dia does not support.

To create a file in one of these formats, select File → Export... from the Main Popup Menu. Choose a name and the desired format in the resulting dialog, which works like a save dialog. An appropriate file extension is automatically added.

## Chapter 9

# Customization

### 9.1 Preferences Dialog

Dia allows you to set a number of customization options that modify how the program works. These options are set by selecting the File → Preferences from the Toolbox Menu Bar. This opens the Preferences dialog. This dialog has tab panes grouping related preferences like: User Interface, Diagram Defaults, View Defaults and Grid Lines.

After you have made all the changes you want, click on OK to apply the changes and close the Preferences dialog. To cancel the changes and return to previous values, click the Close button. You may preview the effect of your changes using the Apply button.

---

### 9.1.1 User Interface

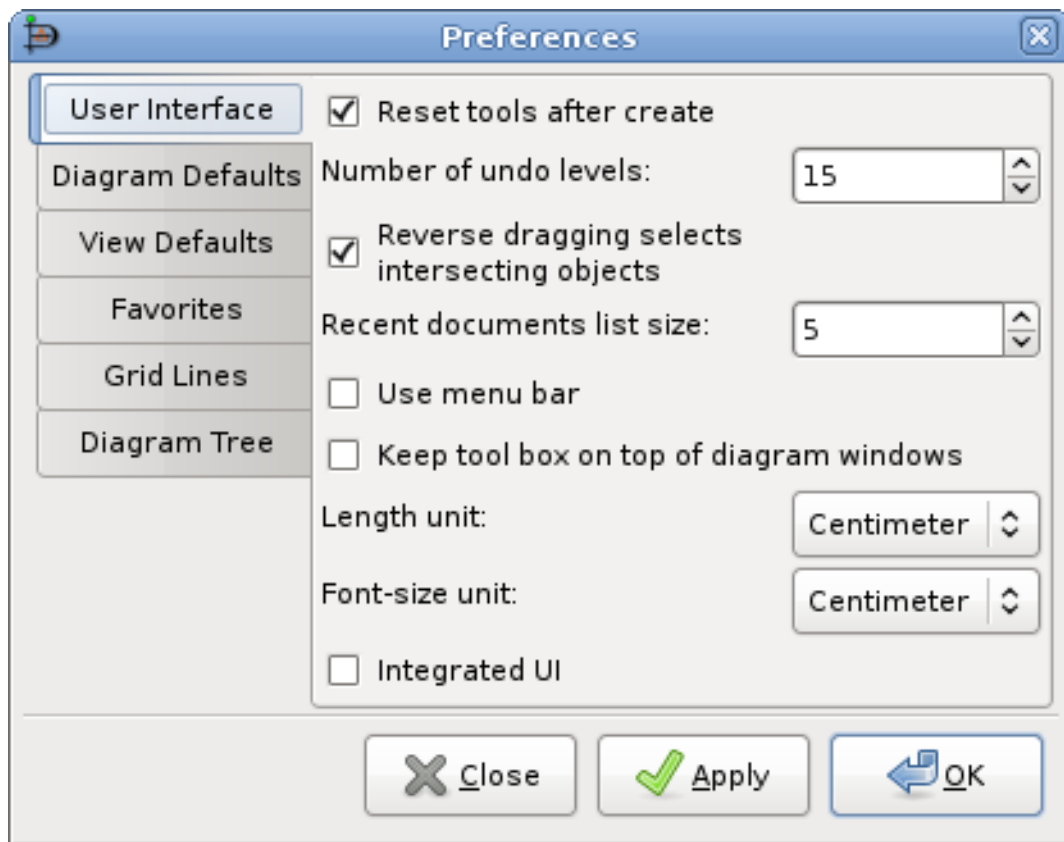

Figure 9.1: User Interface

The User Interface tab pane allows you to change the way Dia works. The configurable properties in the User Interface tab are explained below.

- **Reset tools after create** causes the Modify tool to be selected automatically each time an object has been added to the diagram. This allows you to add an object and then use the Modify tool to select objects without having to go back to the Toolbox. If the Reset tools button is not checked, then the current object tool will "stick" until another tool is chosen. This is useful if you want to draw many shapes using the same tool repeatedly. However, in this case, you will need to manually select the Modify tool in order to select objects.

---

**Tip**

As an alternative to unchecking this box, you can press the Space key after inserting an object to reselect the last object. See [Adding Objects](#) for more information.

---

- **Compress saved files** provides the option to have Dia XML files compressed into much smaller files using gzip or to leave the Dia XML files as plain text so that they can be more easily edited using other software.
  - **Number of undo levels** customizes how many steps that the undo tool remembers. The higher the number, the more steps you can undo to fix an error. However, more undo levels requires more computer memory. Setting the undo level to zero allows the program an unlimited number of undo levels, subject to the available computer memory.
  - **Reverse dragging selects intersecting objects** allows you to create selections by area that only need to cover part of the object you want to select. Normally when you select objects by area, you need to create a selection around the whole of the object
-

you want to select in order to select it. Also, normally dragging from the top-left to the bottom-right is the same as "reverse dragging" -- dragging from the bottom-right to the top-left.

If this option is checked, dragging from the bottom-right to the top-left allows you to select objects that only partially fall into the selection rectangle. Dragging from the top-left to bottom-right still works the same -- objects are only selected if the whole object is inside the selection rectangle.

This option gives you two different ways to select by area, depending on which way you drag the mouse.

- Recent Documents list size allows you to set how many items will be shown in the Recent Documents section of the File menu.
- When Use menu bar is checked, the pull-down menus appear at the top of each Diagram, and the object context menus are accessed by right-clicking on a selected object. If this box is unchecked, these menus do not display at the top of the diagram. Instead, these menus are selected by right-clicking on the canvas, and the object context menus are selected by middle-clicking (on a three-button mouse) on a selected object.

---

**Note**

If you do not have a three-button mouse, you will need to have this box checked. Otherwise, you will not be able to access the object context menus.

---

- Keep tool box on top of diagram windows ensures that the Toolbox window is always in front of all the diagram windows which makes it easier to keep track of and have quick access to the tool at all times.

### 9.1.2 Diagram Defaults

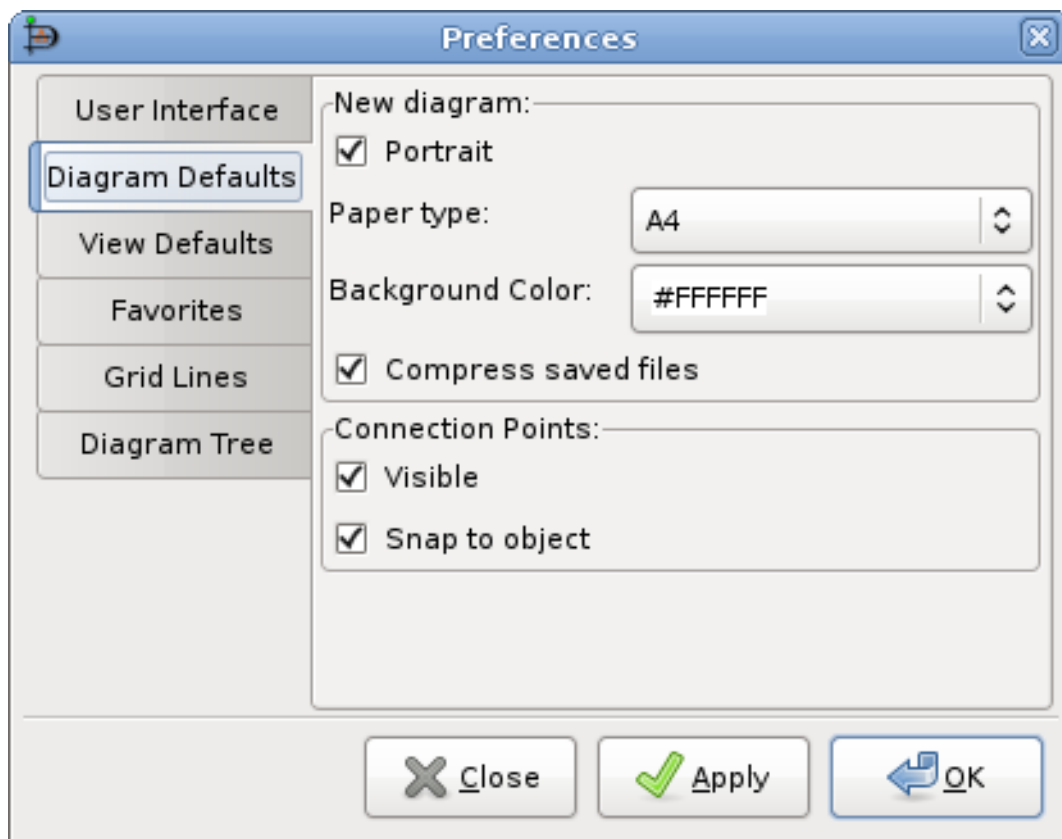

Figure 9.2: Diagram Defaults

The Diagram Defaults tab allows you to set default properties for all new diagrams. These are explained below.

---

- Portrait indicates that the diagram is in portrait orientation on the page. If this is unchecked, then landscape orientation is assumed.
- Paper type allows you to select from a list of paper sizes (e.g., A4, Letter, etc.).
- Background color allows you to set a default background color for all new diagrams. See [Colors](#) for more information on setting colors.
- New Window: Width allows you to set default width (in pixels) of the window when a new diagram is created. You can either enter a number manually or use the increment / decrement buttons.
- New Window: Height allows you to set default height (in pixels).
- New Window: Magnify allows you to set the default zoom value (in percent) for a new diagram. You can either enter a number manually or use the increment / decrement buttons.
- Connection Points: Visible determines whether connection points will be visible by default on new diagrams. When working with a diagram, this can be toggled on or off using the View → Show Connection Points on the Diagram menu bar.

### 9.1.3 View Defaults

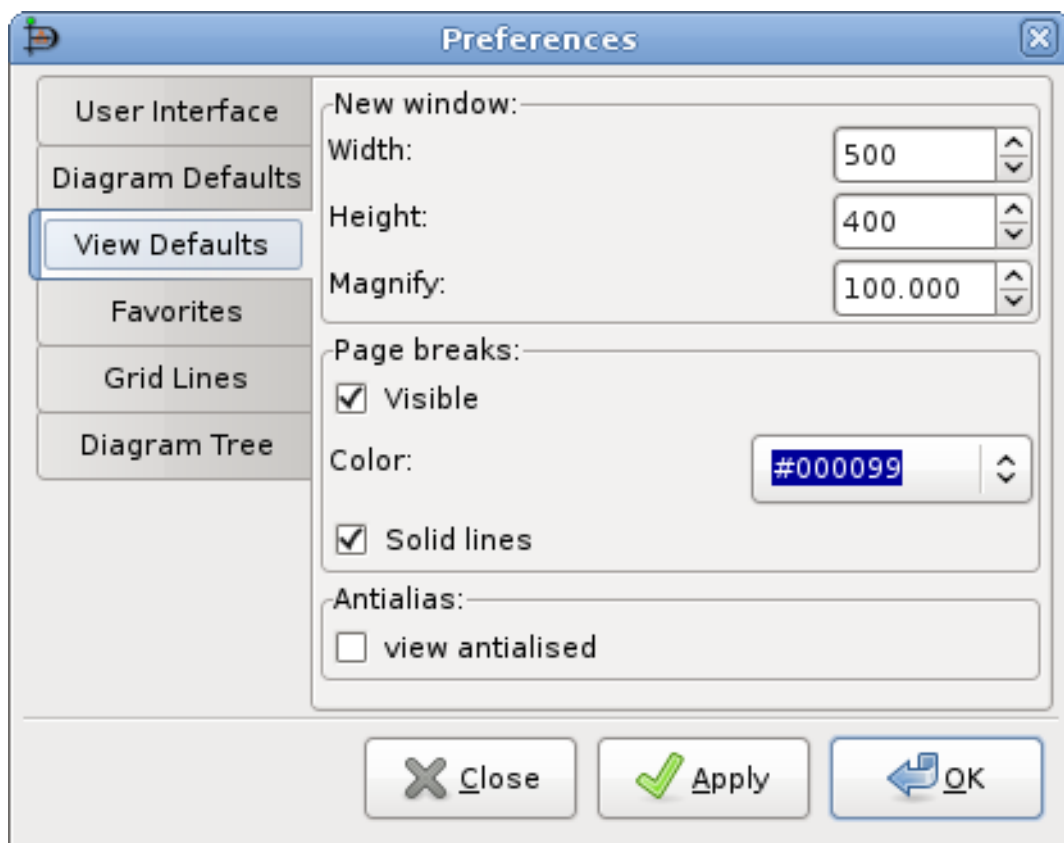

Figure 9.3: View Defaults

This tab allows you to set default properties for the Page break lines.

- Page Breaks: Visible controls whether page break lines will be visible.
- Color allows you to select the default color of the page break lines. This can be changed for a single diagram using the Colors tab on the Diagram → Properties menu choice from the Diagram menu bar.
- Solid lines determines whether the page break lines appear as solid lines or as dashed lines.



### 9.1.4 File export favorites

When exporting files there are often multiple filters capable to save to one format. This preference allows to choose the one used, when not explicit selected in the file export dialog, i.e. By extension gets used.

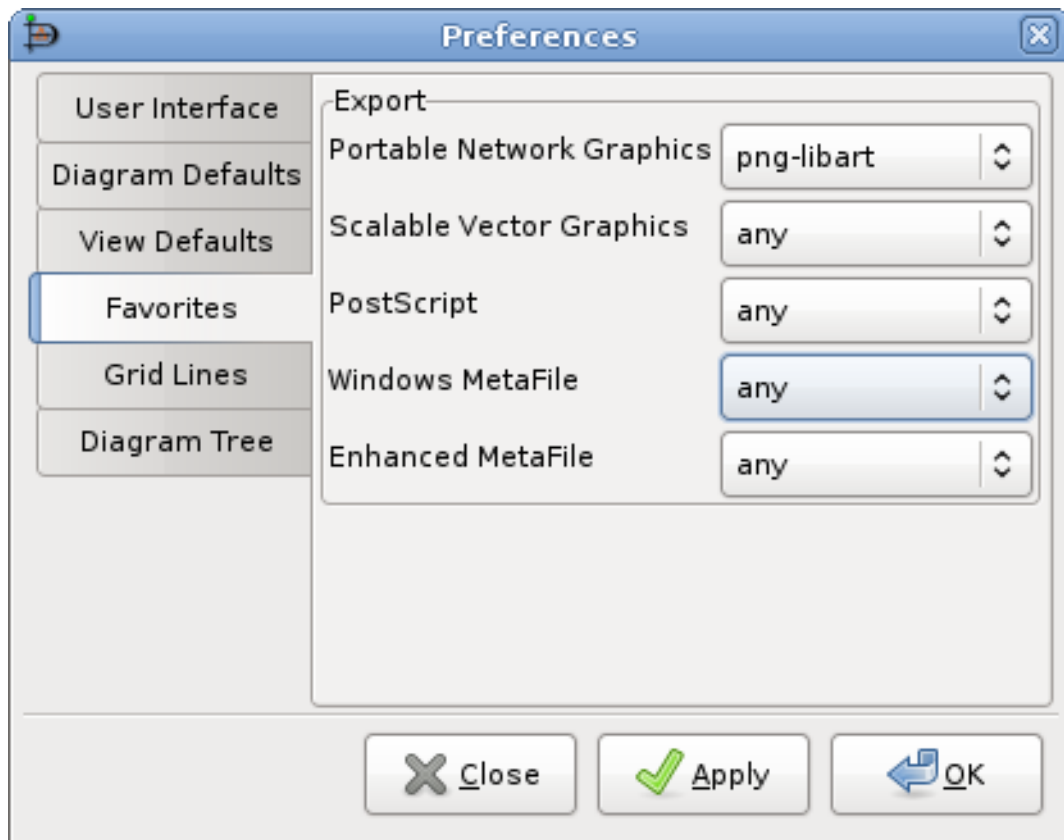

Figure 9.4: File export favorites

### 9.1.5 Grid Lines

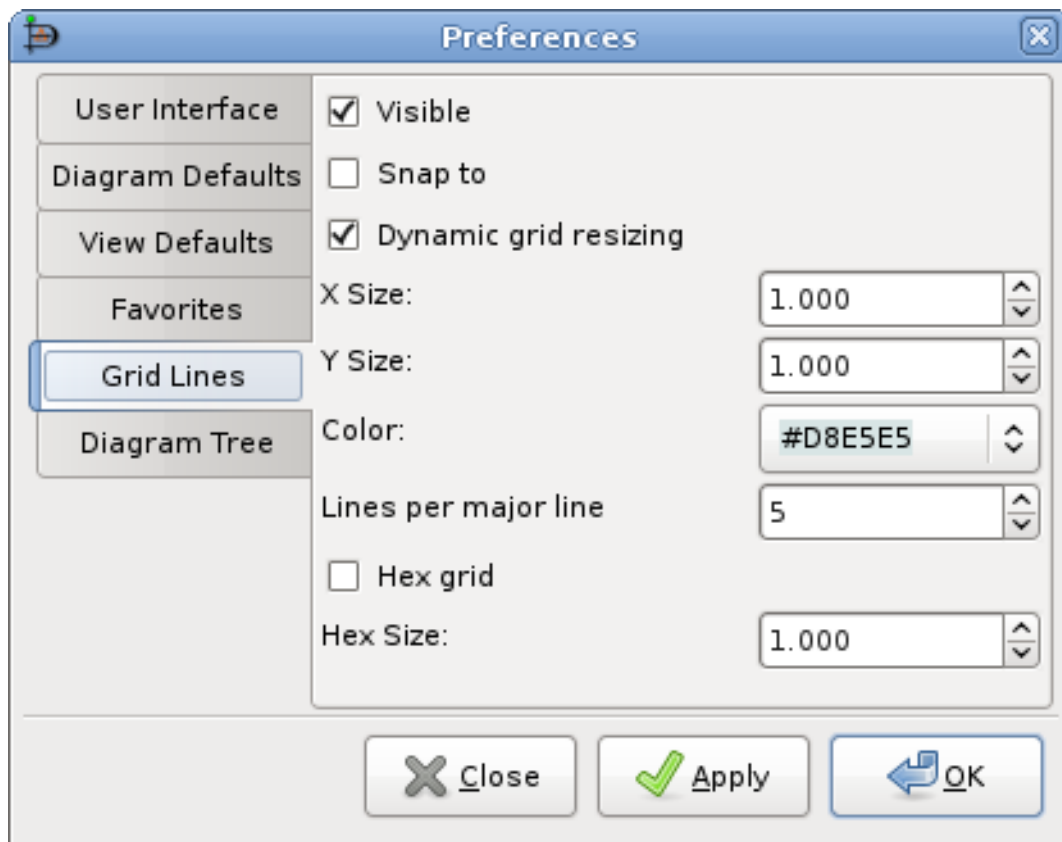

Figure 9.5: Grid Lines

This tab allows you to set default properties for Grid Lines. These may be changed for an individual diagram by selecting the Diagram → Properties from the Diagram menu bar and then selecting the Grid tab. These options are explained below.

- Visible determines whether, by default, grid lines will be visible on new diagrams.
- Snap to determines whether, by default, new diagrams will have snap-to-grid enabled. Snap-to-grid forces object edges to move to the nearest grid line intersection. This makes it easier to align objects, as separate objects snap to the same line. This feature can be toggled on or off using the snap-to-grid button on the bottom of the Toolbox. See [Canvas / Grid Lines](#) for more information. This can also be toggled using the View → Snap To Grid option on the Diagram menu bar.
- Dynamic grid resizing determines whether the grid size changes as the diagram is zoomed in or out. If this box is checked, then the grid lines display as the same size no matter how the diagram zoom is changed. In this case, the X Size and Y Size values have no effect.

If this box is unchecked, then the grid size is set in absolute terms according to the X Size and Y Size values (in centimeters). In this case, the appearance of the grid will change as the zoom changes, so the grid lines will move closer when you zoom out and will spread out as you zoom in.

- X Size determines the distance, in centimeters, between grid lines along the horizontal axis. This only takes effect if Dynamic grid resizing is unchecked.
- Y Size determines the distance, in centimeters, between grid lines along the vertical axis. This only takes effect if Dynamic grid resizing is unchecked.
- Color sets the display color of the grid lines.

- Lines per major line determines the spacing of major (i.e., solid) grid lines. For example, a value of 5 means that every 5th grid line is solid.
  - Hex grid allows you to have a grid of hexagons instead of a rectangular grid.
  - Hex size determines the size of the hexagons, in centimeters, in the hex grid. This option only applies if Hex grid is checked.
-

## Chapter 10

# Managing Layers

### 10.1 Introduction to Layers

In Dia, diagrams consist of the canvas object, layer objects, and diagramming element objects. The layer object can be likened to that of a sheet that sits on top of a canvas. Each sheet can then have diagramming elements added to it to make up a diagram. Each diagram consists of at least one layer and each diagram can consist of as many layers as required by the diagramming author.

As a general purpose, layers aim at being a shortcut for grouping related objects within a diagram. They allow you to isolate the different parts of a diagram, in the way which you can decide to show only certain parts of it and not some others will stay hidden even when exporting or printing the diagram.

---

**Tip**

Use the `--show-layers` command line switch to control which layers are visible when batch exporting.

---

Inside a layer, any operation you would like to perform on objects are possible through the Main Popup Menu, then you can act on objects just the way you use to.

---

**Tip**

Only objects present in the current layer can be selected. If an object doesn't want to be selected, you should check if it is laying in the current layer or not.

---

Each new diagram comes with the default layer labeled "Background". Of course you can change its name and settings to customize it to your needs as you can do with any other layer.

You can use layers to create overlay slide show by drawing each incremental slide in a layer and manipulating which layers are visible. If you want to automate post processing such slide show, you can use `--show-layers` command line switch. For example:

```
dia --show-layers=Background,Slide3 --filter=eps-builtin --export=foo.eps foo.dia
```

will export the Background and Slide3 layers, i.e. the eps output has only these two layers and none others. You would then repeat the export for each combination of layers you need to produce your slides. Using this switch and a shell script or Makefile you can automate the export process quite well.

### 10.2 Managing Layers Basics

The Layers dialog is used to manage the order and visibility of each layer in a diagram.

---

### 10.2.1 Create a New Layer

Creating a new layer is possible by clicking on the New Layer button at the bottom left of the dialog. Since the Layers dialog is not diagram specific but application specific, you will have to choose in which diagram the new layer must go in. To do so, at the top of the Layers dialog, select the diagram you wanted to receive the new layer and then add this new layer to the selected diagram.

The newly created layer will be placed on top of the stack and will become the current layer of the selected diagram.

Then it's possible to edit any new object of your choice, copy and paste from any other layer or diagram as you could do it in single layer diagram.

### 10.2.2 Selecting Layers

A layer is said as being activated when it is selected in the Layers dialog. To select a layer simply click on its name in the dialog. The selected layer will then become highlighted. Changes to the diagram are made to the currently selected layer only.

---

**Note**

Only one layer can be selected at a time. That way you can do anything you like in this selected layer without affecting other layers on your diagram.

---

### 10.2.3 Ordering Layers

Next to the New Layer button at the bottom of the Layers dialog, are two useful buttons which allow you to set the stack order of each layer you created.

Those two buttons are used to raise and lower layers in the hierarchy of layers. The button with the up arrow is used to raise the active layer while the other is for lower the position within the hierarchy.

Ordering layers can be useful when you want hide some parts of an object with another one.

### 10.2.4 Deleting Layers

When a layer is not required you can delete it. When deleting a layer, it and all of the objects contained in the layer are removed from the canvas. Layers are deleted by clicking on the Delete Layer button. Of course this will only affect the currently selected layer.

Doing so on regular basis is the better way to keep your diagram clean and light for when you want to export it to another format other than the native Dia format.

### 10.2.5 Renaming Layers

Layers can be renamed to express the part of the diagram they represent, giving them the ability to be rapidly located among others. Most importantly, layers can be shown or hidden depending on what part of the diagram you would like to show.

Double-clicking on the name of the layer opens the Edit Layer Attributes dialog, which displays the current name of the layer in a textbox. Enter a new name for the layer in the textbox. To confirm the changes, depress the OK button. Selecting the Cancel button will close the Edit Layer Attributes dialog without making any changes.

---

**Tip**

Naming layers that describe the purpose of the layer is a useful way to remember what it is for. Don't hesitate to create many different layers in your diagram, Dia doesn't constrain you on the number of layers you've created, so feel free to adjust the hierarchy of the diagram to your own needs.

---

## 10.3 Viewing Layers

Now that you've seen what are the basics of manipulating layers, you will more easily understand why *layers* are such a powerful tool when you are building and maintaining diagrams with Dia.

Understanding what layers are for can dramatically improve the quality and the visual effect your diagrams will produce.

For instance, imagine you are building a diagram with lots of objects in it, like an Electrical or UML diagram, if you drop all of your objects in the same layer, meaning the background, after a while you will get a huge unmanageable draft you won't be able to do anything with it. It will be a pain to change anything in it, you will waste time trying to remember what object is connected to that object which seems to take all the space in the middle of the mixed up objects you already put there.

Since Dia is a *Structured Diagram Builder*, all the diagrams you will build with it will be naturally structured and broken down to many little pieces. Using a layered approach better manages lots of pieces with more ease and efficiency than you could do with a single monolithic block of objects.

---

### Note

By definition, a diagram should be structured. So breaking it down into several logical parts should be an easy process. That's where *layers* become a very useful and important tool for the management of the content of diagrams. They allow you to isolate each of these parts in separated slides, so it becomes a real pleasure to manipulate them in any way you like.

---

The Eye Icon to the left of the layer name is what make layers so useful. It allows you to show or hide the corresponding layer. Meaning if for any reason you decided to not show a particular layer, simply click on the Eye Icon and the layer and everything it contains will disappear from the Canvas. If you hold down the Shift key and click Eye Icon you can hide all the other layers except for the current layer, and if you click again while still holding the Shift key all Layers will be shown again.

Viewing only certain layers is really useful when you want manipulate a small part of your diagram without affecting the rest. Some users create separate layers to hold all their text objects and use different layers to hold translations into other languages. You can also work that way if you want to print your diagram on different pages or testing different settings which can affect the layout of that part. Again, feel free to experiment with layers, if set up properly they can make your diagram look much better.

---

### Note

In Dia, *Layers* creation and manipulation are as common as drawing or selecting objects in the diagram. You must get your hands on them, because you will probably have to use them anytime you will want to create a new diagram.

---

## Chapter 11

# Custom Shape Module

### 11.1 Custom-shape Module introduction

The custom shape module allows you to create new shapes for Dia without writing any C code. Instead, you just have to write a simple XML file describing the shape. This opens up the job of creating new shapes for dia to non programmers as well.

The actual shape is described using a subset of the SVG specification. The line, polyline, polygon, rect, circle, ellipse, path and g elements are supported. Note that the path element only supports the M,m,L,l,H,h,V,v,C,c,S,s,A,a,Z and z commands. Transformations and CSS units are not supported (only `user` units are), and only a limited set of the CSS attributes are supported.

A number of connection points can be associated with the shape, which are specified in the same coordinate system as the shape description. One of the connection points should be marked as the main connection point. This main connection point will be used if a line is dragged onto the object but not on one of it's connection points.

A text box can be associated with the shape. The text box is also specified in the same coordinate system as the shape description.

To choose size and position of the text box, you can think of one rectangle to contain the text box, and another one to contain all other svg elements (call it the image rectangle): When you get the shape to the canvas, and write some text, all of it has to go inside the text box; if necessary, this text box will grow, and, in the same proportion, the image rectangle will also grow.

The rest is taken care of for you (resizing, moving, line connection, loading, saving, undo, etc).

### 11.2 Shapes

A typical shape file may look something like this:

```
<?xml version="1.0"?>
  <shape xmlns="http://www.daa.com.au/~james/dia-shape-ns"
        xmlns:svg="http://www.w3.org/2000/svg">
    <name>Circuit with identifiers - NPN Transistor</name>
    <icon>npn.xpm</icon>
    <connections>
      <point x="0" y="0"/>
      <point x="6" y="-4" main="yes"/>
      <point x="6" y="4"/>
    </connections>

    <aspectratio type="fixed"/>

    <textbox x1="4" y1="-3" x2="12" y2="3" />
```

```

<svg:svg>
  <svg:line x1="0" y1="0" x2="3" y2="0" />
  <svg:line x1="3" y1="-3" x2="3" y2="3" />
  <svg:line x1="3" y1="-2" x2="6" y2="-4" />
  <svg:line x1="3" y1="2" x2="6" y2="4" />

  <svg:polyline points="5,4 6,4 5.6154,3.0769" />
</svg:svg>

</shape>

```

Only the `name` and `svg` elements are required in the shape file. The rest are optional.

The `name` element give the name of the object. The name is a unique identifier for this shape that is used for saving and loading.

As in the example, you may use "compound names". Many shapes have first part of its name to indicate the sheet in which they appear, but this is optional.

The `icon` element specifies an xpm file or a png file that is used as the icon in the dia toolbox. The filename can be relative to the shape file. If it is not given, a default custom shape icon will be used.

The `connections` section specifies a number of connection points for the shape. The coordinate system for these points is the same as the coordinate system used in the svg shape description.

The `aspectratio` element allows you to specify how the shape can be distorted. The three possibilities are:

- `<aspectratio type="free"/>` - Any aspect ratio is OK (the default)
- `<aspectratio type="fixed"/>` - Fix the aspect ratio for this shape.
- `<aspectratio type="range" min="n" max="m"/>` - Give a range of values.

The last option allows you to specify a range of allowable amounts of distortion, which may be useful in some cases.

The `textbox` element allows you to associate some text with the shape. The syntax is:

```
<textbox x1="left" y1="top" x2="right" y2="bottom"/>
```

(Only one textbox per shape) Where the attributes give the bounds of the text box in the same coordinate system as the SVG shape description.

There are some optional attributes on `<textbox/>` namely

**resize="no"** : by default the textbox is resized with the text

**align="center"** : "center" is default, also "left" and "right" can be used

Shapes are given a default size on creation. If that default size does not fit your needs you can overwrite it by (one or both): `<default-width>1cm</default-width>` `<default-height>3cm</default-height>` The default unit "cm" can be omitted.

The `svg` element describes the shape. The width and height attributes are ignored, and only given to comply with the SVG specification. For more information on SVG, see the W3C pages about the format at: <http://www.w3.org/Graphics/SVG>

The next section details what parts of the SVG spec can be used in shape files.



## 11.3 The Shape Description

The Scalable Vector Graphics format is used to describe the shape. That is why the separate namespace is used for that part of the file.

### 11.3.1 Style attribute

Each of the SVG drawing elements understands the style attribute. The attribute should be of the form:

```
<svg:whatever style="name1: value1; name2: value2; ... name42: value42"/>
```

Currently only the following style attributes are understood:

- `stroke-width` - The width of the line, relative to the user specified width.
- `stroke-linecap` - The line cap style. One of `butt`, `round`, `square`, `projecting` (a synonym for `square`), or `default`.
- `stroke-linejoin` - The line join style. One of `miter`, `round`, `bevel` or `default`.
- `stroke-pattern` - The dash pattern. One of `none`, `dashed`, `dash-dot`, `dash-dot-dot`, `dotted` or `default`.
- `stroke-dashlength` - The length of the dashes in the dash pattern, in relation to the user selected value (default is a synonym for 1.0).
- `stroke` - The stroke colour. You can use one of the symbolic names `foreground`, `fg`, `default`, `background`, `bg`, `inverse`, `text` or `none`, or use a hex colour value of the form `#rrggbb`.
- `fill` - The fill colour. The same values as for `stroke` are used, except that the meaning of `default` and `inverse` are exchanged. By default, elements are not filled, so to get the default fill, use `"fill: default"`

---

#### Tip

So to draw a rectangle with a hairline stroke, the following would do the trick:

```
<svg:rect style="stroke-width: 0" x="..." y="..." width="..."  
  height="..." />
```

---

Ordinates x and y grow as in Dia.

### 11.3.2 Recognised drawing elements

The recognised drawing elements are:

- `<svg:g>`

This is the group element. You can place other drawing elements inside it. The contents of the style attribute on a group element will propagate to the contained elements (unless they override it).

- `<svg:line x1="..." y1="..." x2="..." y2="..." />`

This element is a line.

---

- `<svg:polyline points="..." />`

This is a polyline. That is, a number of connected line segments. The points attribute holds the coordinates of the end points for the line segments. The coordinates are separated by white space or commas. The suggested format is "x1,y1 x2,y2 x3,y3 ...".

- `<svg:polygon points="..." />`

This is a polygon. The points argument has the same format as the polyline.

- `<svg:rect x1="..." y1="..." width="..." height="..." />`

This is a rectangle. The upper left corner is (x1,y1), and the lower right corner is (x1+width,y1+height).

- `<svg:image x1="..." y1="..." width="..." height="..." xlink:href="..." />`

This is an external image. The upper left corner is (x1,y1), and the lower right corner is (x1+width,y1+height). There are two forms of links supported, an absolute filename of the form "file:///home/user/image.png" or a relative one without the "file://" prefix like in "image.png". The latter form is preferred because it is installation independent. The filename is relative to the shape file placement. In the above example PNG and shape need to be in the same directory. Inlined image data is also supported with `xlink:href="data:image/png;base64,..."`

- `<svg:circle cx="..." cy="..." r="..." />`

This is a circle with centre (cx,cy) and radius r.

- `<svg:ellipse cx="..." cy="..." rx="..." ry="..." />`

This is an ellipse with centre (cx, cy) and radius rx in the x direction and ry in the y direction.

- `<svg:path d="..." />`

This is the most complicated drawing element. It describes a path made up of line segments and bezier curves. It currently does not support the elliptic arc or quadratic bezier curves. The d string is made up of a number of commands of the form "x arg1 arg2 ..." where x is a character code identifying the command, and the arguments are numbers separated by white space or commas. Each command has an absolute and relative variant. The absolute ones are spelled with an upper case letter. The relative ones are spelled with a lower case letter, and use the end point of the previous command as the origin.

The supported commands are:

- M x, y - Move cursor
- L x, y - Draw a line to (x,y)
- H x - Draw a horizontal line to x
- V y - Draw a vertical line to y
- C x1, y1 x2, y2, x3, y3 - Draw a bezier curve to (x3,y3) with (x1,y1) and (x2,y2) as control points. C (uppercase) indicates that absolute coordinates will follow; c (lowercase) indicates that relative coordinates will follow.
- S x1, y1 x2, y2 - Same as above, but draw a 'smooth' bezier. That is, infer the first control point from the previous bezier. S (uppercase) indicates that absolute coordinates will follow; s (lowercase) indicates that relative coordinates will follow.
- A (rx ry x-axis-rotation large-arc-flag sweep-flag x y) +- Draw an elliptical arc from the current point to (x, y). The size and orientation of the ellipse are defined by two radii (rx, ry) and an x-axis-rotation. The center is automatically calculated. large-arc-flag and sweep-flag contribute to the automatic calculations and help determine how the arc is drawn. A (uppercase) indicates that absolute coordinates will follow; a (lowercase) indicates that relative coordinates will follow.
- Z - Close the path.

If the path is closed with z or Z, then it can be filled. Otherwise, it will just be drawn.

- `<svg:text x="..." y="..." style="...">...</svg:text>`

A text in the shape. The text has to be enclosed in the tags

The parameters are:

- x, y - The text position

- `style` - Text formatting options  
The following style options are supported:
- \* `font-size` - font size in pt

## 11.4 Shapes in Shapes aka. Subshapes

Adding independently resizable symbols into your custom shapes is possible by creating subshapes. This is done by some extra attributes on the group element.

```
<svg:g
  subshape="true"
  v_anchor="fixed.bottom"
  h_anchor="fixed.left"
  default_scale="1.0">
```

**v\_anchor** Supported values: *"fixed.top"* *"fixed.bottom"* *"proportional"* The vertical anchoring of the subshape.

**h\_anchor** Supported values are: *"fixed.left"* *"fixed.right"* *"proportional"* The horizontal anchoring of the subshape.

**default\_scale** currently unused

## 11.5 Extended Attributes

To extend your custom shape with custom attributes you can put something like:

```
<ext_attributes>
  <ext_attribute name="Integer" type="int" />
  <ext_attribute name="String" type="string" />
  <ext_attribute name="Float" type="real" />
</ext_attributes>
```

between the `<shape></shape>` tags. The effect will be some custom properties in your object. They are editable by the properties dialog and will be loaded and saved with your diagram. To programatically access them use `"custom:<name>"`

## 11.6 The Sheet description

You can put several shapes in one sheet: the shapes you create or any other shape or object "belonging" to other sheets.

A simple sheet file may look something as this:

```
<?xml version="1.0" encoding="utf-8"?>
<sheet xmlns="http://www.lysator.liu.se/~alla/dia/dia-sheet-ns">
```

```
<name>Circuit with identifiers</name>
<name xml:lang="es">Circuito con identificadores</name>
<description>Components for circuit diagrams</description>
<description xml:lang="es">Componentes para diagramas de circuitos
</description>
<contents>
  <object name="Circuit with identifiers - NPN Transistor">
    <description>A bipolar npn transistor</description>
    <description xml:lang="es">Un transistor bipolar npn identificable
    </description>
  </object>
  <object name="UML - Objet">
    <description>An UML object</description>
    <description xml:lang="es">Un objeto UML</description>
  </object>
</contents>
</sheet>
```

## 11.7 How Dia helps to create and manage sheets and shapes.

You can use Dia with its available elements to draw a shape and then export it to a shape file, by using File (of diagram) → Export → By extension → Shape.

But until now, this shapes don't have any text box. (They are expected to manage some svg:text but not a text box). If you need one, you can edit the file.

Together with the shape file, you get a png file (after accepting the proposed size) which can be used for the shape's icon.

By using File(of principal menu) → Sheets and Objects you can create new sheets; and add, remove and partially edit shapes; and copy or move shapes from one sheet to other.

## 11.8 Design Notes

The custom shape code is designed so that a sheet of objects can be self contained in a single directory. Installing new shapes can be as easy as untaring a .tar.gz file to ~/.dia/shapes or \$(prefix)/share/dia/shapes, with the sheet description going to ~/.dia/sheets

If you have any suggestions for this code, please tell me.

James Henstridge [james@daa.com.au](mailto:james@daa.com.au) with some modifications written by Dolores Alia de Saravia [loli@unsa.edu.ar](mailto:loli@unsa.edu.ar)

## Chapter 12

# Dia command line

### 12.1 Introduction

Dia can be used via command line, And, more, FROM command-line (batch treatment, e.g. to export to another file format). Do not forgot `--nosplash` option in case of usage of dia from command line, to avoid Dia's splash screen.

### 12.2 Command line manual

#### 12.2.1 dia

dia — a diagram drawing program

#### Synopsis

```
dia [-c] [--credits] [-e OUTPUT] [--export=OUTPUT] [-L LAYER, LAYER, ...] [--show-layers=LAYER, LAYER, ...] [-h] [--help] [-n] [--nosplash] [-s WxH] [--size=WxH] [-t FORMAT] [--filter=TYPE] [-v] [--version] [file ...]
```

#### Description

**Dia** is used to create diagrams. Dia has a number of basic tools, like lines and boxes but can also dynamically load *sheets*. A sheet is a collection of tools that are used in a certain type of diagram.

Most diagram objects in **Dia** have *connection points*. Lines can be connected to these connection points and this way graph structures can be formed. When objects are moved or resized the connections will follow the objects.

Diagrams drawn in **Dia** can be exported to various formats.

#### Options

**Dia** accepts the following options:

- `-c --credits` Display credits list and exit.
- `-e OUTPUT --export=OUTPUT` Export loaded file to OUTPUT and exit.
- `-h --help` Display a list of all commandline options.
- `-n --nosplash` Do not show the splash screen.

**-s *WxH* --size=*WxH*** Export loaded file in decimal given width and/or height. It is allowed to only select width or height. E.g. `--size=520x` exports an image that is 520 pixels wide, while `--size=x900` exports an image of 900 pixels height.

---

**Note**

This option is currently only implemented for the PNG export filter.

---

**-L *LAYER, LAYER, ...* --show-layers=*LAYER, LAYER, ...*** Only include specified layers when exporting. Layers can be specified either as a layer name, the layer number or a numeric range X-Y of layers. `--show-layers=background,2-5` shows the layer named background and layers 2-5, `--show-layers=2-` shows layers 2 and up.

**-t *TYPE* --filter=*TYPE*** Export loaded file with TYPE and exit. Formats and variants are described below.

**--list-filters** List export filters/formats and exit.

**-v --version** Display **dia** version and exit.

## Export Formats

The following export formats are supported by **dia**. Most formats are implemented by plug-ins so their availability depends on compile- and runtime-configuration.

- `cgm` (Computer Graphics Metafile, ISO 8632)
- `dia` (Native dia diagram)
- `dxf` (Drawing Interchange File)
- `eps` or `eps-builtin` or `eps-pango` (Encapsulated PostScript)

The format specifications `eps` and `eps-pango` both use the font renderer of the Pango library, while `eps-builtin` uses a dia specific font renderer. If you have problems with Pango rendering, e.g. Unicode, try `eps-builtin` instead.

- `fig` (XFig format)
- `mp` (TeX MetaPost macros)
- `pdf` (Portable Document Format)
- `plt` or `hpgl` (HP Graphics Language)
- `png` (Portable Network Graphics)
- `shape` (Dia Shape File)
- `svg` (Scalable Vector Graphics)

There are three different SVG exporters with Dia having different specializations. `cairo-svg` is turning text to shapes to become independent of font availability on the target system. `dia-svg` is based on Dia core code only. It's translating all Dia's rendering capabilities as closely as possible to SVG. `svg-py` - as SVG renderer implemented in Python - is producing plain SVG. It is the most hackable version to allow some user adaptations

- `pstricks-tex` (TeX PSTricks macros)
  - `pgf-tex` (TeX PGF/tikz macros)
  - `vdx` (Visio Diagram XML)
  - `wpg` (WordPerfect Graphics)
  - `wmf` (Windows MetaFile)
-

## Files

**dia** creates a directory `.dia` in the user's home, which contains different files to store user preferences. To reset **dia** to its default behaviour, just remove the respective file:

- `defaults.dia`: contains default values for elements (XML format).
- `diarc`: keeps **dia** preferences (ASCII).
- `history`: keeps the list of last edited diagrams (ASCII).
- `menurc`: contains an automated accelerator map dump (Lisp).
- `persistence`: contains GUI information, e.g. open windows (XML).
- `pluginrc`: the list of loaded plugins (XML).

## See Also

[Pango](#)

[X \(1\)](#)

[xfig \(1\)](#)

[inkscape \(1\)](#)

## Copyright

Copyright 1999 Alexander Larsson.

Permission to use, copy, modify, and distribute this software and its documentation for any purpose and without fee is hereby granted, provided that the above copyright notice appear in all copies and that both that copyright notice and this permission notice appear in supporting documentation.

## Authors

Alexander Larsson

This manual was written by Fredrik Hallenberg.

---

## Chapter 13

# Authors

Dia was created by Alexander Larsson and is currently maintained by Hans Breuer and other dedicated volunteers. To find more information about Dia, please visit the official web page, [live.gnome.org/Dia](http://live.gnome.org/Dia). Please send all comments, suggestions, and bug reports to the [GNOME bug tracking database](#). You can also sign up to the [Dia mailing list](#).

This manual was written by Henry House ([hajhouse@houseag.com](mailto:hajhouse@houseag.com)), Judith Samson ([judith@samsonsource.com](mailto:judith@samsonsource.com)), Kevin Breit ([battery841@mypad.com](mailto:battery841@mypad.com)) and Alan Horkan ([horkana@tcd.ie](mailto:horkana@tcd.ie)). It was significantly expanded and revised in August 2007 by Mark Dexter ([dextercowley@gmail.com](mailto:dextercowley@gmail.com)).

---



## Chapter 14

# License

### 14.1 License

This program is free software; you can redistribute it and/or modify it under the terms of the *GNU General Public License* as published by the Free Software Foundation; either version 2 of the License, or (at your option) any later version.

This program is distributed in the hope that it will be useful, but WITHOUT ANY WARRANTY; without even the implied warranty of MERCHANTABILITY or FITNESS FOR A PARTICULAR PURPOSE. See the *GNU General Public License* for more details.

A copy of the *GNU General Public License* is included as an appendix to the *GNOME Users Guide*. You may also obtain a copy of the *GNU General Public License* from the Free Software Foundation by visiting [their Web site](#) or by writing to

Free Software Foundation, Inc.  
59 Temple Place - Suite 330  
Boston, MA 02111-1307  
USA